



---

# Industrial Technology and Model Rockets

A Teacher's Guide and Curriculum for Grades 6-12

---

Developed by Richard Kalk, Ed. D. & Steve Wash  
Edited by Ann Grimm

[EstesEducator.com](http://EstesEducator.com)



[educator@estesrockets.com](mailto:educator@estesrockets.com)

800.820.0202

© 2012 Estes-Cox Corp.

# TABLE OF CONTENTS

Introduction .....	4
Goals and Student Outcomes .....	5

## Unit Plans

1. Lesson 1 (1 day): History of Aviation .....	6-13
2. Lesson 2 (2 days): The Airplane - How it Flies .....	14-29
3. Lesson 3 (1 day): The Airport .....	30-35
4. Lesson 4 (1 day): Let's Fly! .....	36-44

## Appendix A

### Student Activity Sheets

#1A Myths and Early Flight Attempts .....	46-47
#1B Balloon History .....	48-49
#1C Glider History .....	50
#1D Airplane History .....	51
#1E Aviation Advancements .....	52
#2A Airplane Components .....	53
#2B Bernoulli's Principle .....	54
#2C The Wing .....	55
#2D Connect the Dots .....	56
#2E Three Axis Motion .....	57
#2F Control Surface Effects .....	58
#2G Aerodynamics .....	59
#2H Climbs and Dives .....	60
#2I Coordinated Turn .....	61
#2J The Cockpit .....	62
#2K Flight Controls .....	63-64
#2L Maneuver Puzzle .....	65
#3A Airport Diagram .....	66-67
#3B Communication Codes .....	68
#3C Crossword Puzzle Review .....	69
#4A Glider Trimming .....	70

## Appendix B

Certificates .....	71
Course Completion - Master Aviator .....	A
Time Award .....	B
Distance Award.....	C
Altitude Award .....	D
Circling Award .....	E

## INTRODUCTION

This curriculum was designed for teachers wanting to expose their students to aviation at the early grades and provide a hands-on experience to reinforce the academic principles.

Aerospace education is a topic that fascinates students at all grade levels making it one of the best motivational tools available. Estes model rocketry is an excellent avenue to teach this subject, but some teachers are reluctant to expose their students to rocketry until the fifth grade leaving a void for those younger. This curriculum was developed to provide the earlier grades a meaningful aerospace education unit. Though particularly suited for those with little to no aviation experience, this curriculum is applicable to all.

Aviation is a large part of our lives and always will be. We owe our youth the opportunity to experience aviation as early as possible. By studying the history and development of the airplane, physical laws of science are learned that are the cornerstone of aerospace technology for today and the future. Because the curriculum is oriented for the second, third and fourth grades, concepts are presented without the need for mathematical analysis. However, there are opportunities for students to make linear measurements and learn about angular displacement (degrees).

Intended as a first look at aviation, this curriculum explores aviation history from mythology to the present and explains the scientific principles making flight possible. The functions of each airplane component are discussed as well as how the pilot commands the airplane to fly. Rounding out the aviation experience is an explanation of the airport and its facilities. To provide a hands-on experience, reinforcing the concepts taught, the curriculum is used in conjunction with the Estes Hi-Lite® Light Glider to accomplish a variety of actual flying activities. Fun classroom activities are also included for additional motivation during the academic portions of the curriculum while master copies of awards and certificates are provided for closure and to instill a sense of self-accomplishment for the students.

The Aviation Curriculum is a natural beginning for aerospace studies. As a stand alone document, it is ready to use without any additional background research, but can be expanded upon as your experience grows. You then have the latitude to continue the aerospace education with rocketry.

## **GOALS**

- \* Bring science to life through the experience of building and flying a model airplane.
- \* Integrate aviation with academic studies.
- \* Show how scientific principles are useful in our daily lives.

## **STUDENT OUTCOMES**

The student will be able to:

- \* Trace the evolution of the airplane.
- \* Understand the scientific principles responsible for buoyancy and lift.
- \* Identify an airplane's components and describe their function.
- \* Explain the four forces acting on an airplane.
- \* Show how the airplane's components change its attitude about the three axes.
- \* Describe the actions of a pilot to command an airplane to fly.
- \* Understand the operation of the airport's facilities.
- \* Follow instructions and build a flying model airplane.
- \* Fly a model airplane and make flight performance adjustments based upon newly acquired knowledge.

## Lesson 1 (One Day)

### HISTORY OF AVIATION

#### Objective of the Lesson:

#### The student will be able to:

- \* Recall some early flight activity up to Leonardo Da Vinci.
- \* Recall how man first flew.
- \* Explain how a balloon works.
- \* Tell why early gliders in the 1800's couldn't be powered.
- \* Identify who first achieved manned powered flight.

#### Background for the Teacher

Since the creation of time, mankind has been obsessed with the desire to fly. History is riddled with many attempts by humans to conquer the bonds of earth. As early as 3500 BC, legends tell of kings that have flown like birds or have piloted flying thrones like ancient aviators. Greek mythology tells of Icarus and Daedalus, who in 1100 BC fashioned birdlike wings of feathers, thread and wax to escape imprisonment on the island of Crete. Not heeding the warnings of Daedalus, Icarus' father, Icarus flew too high, causing the sun's heat to melt the wax which held the feathers in place. Icarus fell from the sky, plummeted into the sea and drowned. The first concrete evidence of flight appears in 300-400 BC with the invention of the kite by the Chinese. Shortly afterwards in the 200's BC, Archimedes (a Greek mathematician and inventor) discovered the principle of buoyancy. He determined that matter which weighed less than equal volumes of water (less density) would float in the fluid. At the time he never applied his discovery to air, which is the principle behind man's first successful flight. It would be over 1700 years later that visionaries such as Leonardo Da Vinci would approach flight in a scientific matter. Separating fact from fiction, he experimented with manned flight in 1500 AD. He designed and sketched flying machines with wings that flapped like birds. Though never built and flown, these early *ornithopters* were the beginning of winged flight. Today, flying toy ornithopters are available which are based upon the works of Da Vinci. Starting in the 1700's, aviation began to bloom and took on three different forms: balloons, gliders and powered flight.

#### Balloons

The first successful manned flight occurred in 1783 over the skies of Paris. Two French brothers, Jacques and Joseph Montgolfier, constructed a hot air balloon of linen. Not understanding how the balloon actually worked, they determined that once filled with hot air, the balloon would float. Conducting a demonstration for the Academy of Science in Paris, the Montgolfiers successfully flew a balloon carrying a sheep, duck and rooster. Then, on November 21, 1783, the Montgolfier balloon, carrying Jean F. Pilatre de Rozier and Marquis d'Arlandes, successfully flew over Paris. Reaching altitudes of 300 feet, the balloon floated for over 5 miles.

The Montgolfiers never associated Archimedes' principle of buoyancy with their

balloon, but others that followed did. These later pioneers understood that air behaves no different than water when examining buoyancy. Hot air is lighter (less dense) than colder air, so a balloon filled with hot air will weigh less than an equal volume of colder air. The balloon will *float* in the sea of colder air just like a cork floating in water. Soon, balloonists discovered that using even lighter gases than hot air, such as hydrogen and helium, created more buoyancy. These balloons were capable of carrying heavy weights such as cargo and passengers.

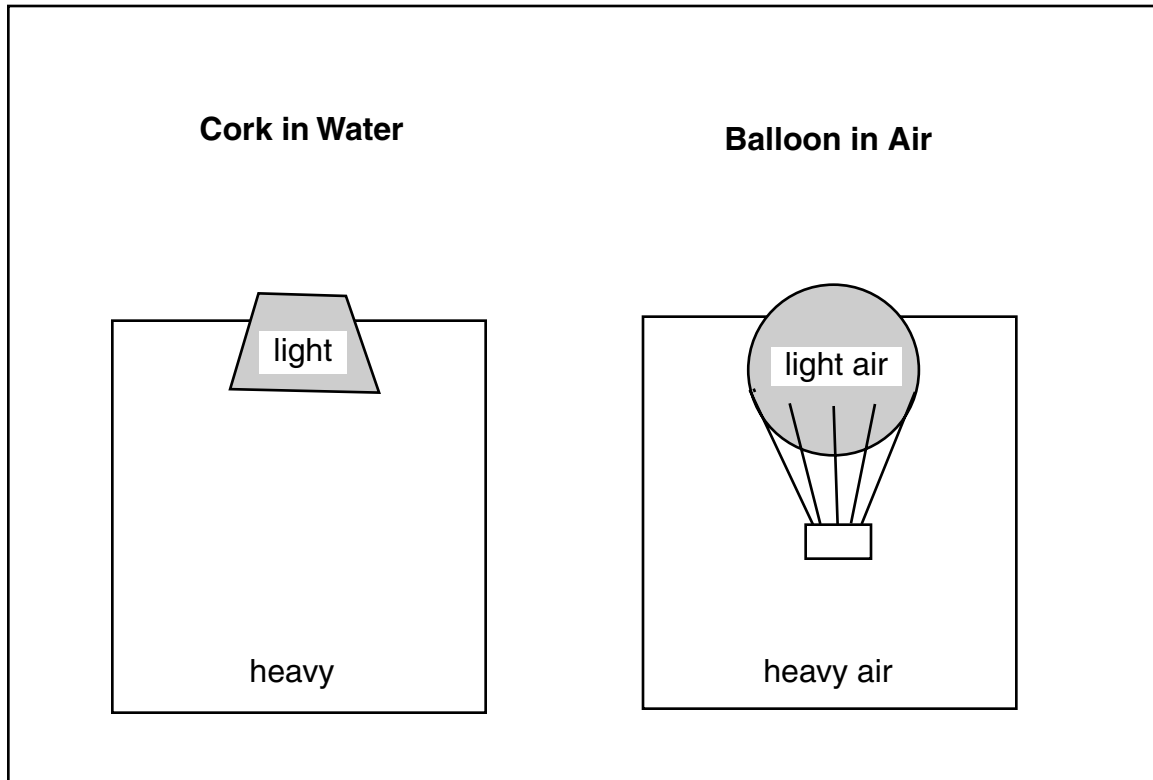

Balloons became very sophisticated. Engines with propellers and control surfaces were added to make these *airships* manageable. Balloons became a routine mode of transportation to travel long distances before large passenger airplanes were developed. Probably the most famous airships were the *Zeppelins* of the early 1900's. Named after their German inventor, Ferdinand von Zeppelin, these hydrogen filled airships with internal frames originally carried passengers for commercial travel. Later, the giant airships were used by the Germans for reconnaissance and dropping bombs during WWI.

Though not as popular as in the early 1900's for commercial uses, balloons are widely used today for recreational flying. Have you seen the Goodyear blimp lately?

## Gliders

Leading the way for the conquest of winged flight was an Englishman, Sir George Cayley. He was a youth when the Montgolfier brothers flew their balloon and became very interested in flight. He experimented with balloons of his own and studied the effect of airflow around objects. In 1804, he built and successfully flew the first unmanned glider. Although it was just a small model, it led the way for all to follow. Working on a full sized glider, Cayley later successfully built and flew a glider carrying a human passenger. Sir George Cayley was on the brink of discovery for powered flight, foreseeing gliders with propellers to propel them. Had lightweight engines been available in his time, history could have been changed.

Until the 1890's no one ever piloted a glider. That changed when Otto Lilienthal, a German engineer, entered the arena. From 1891 to 1896 Lilienthal successfully conducted controlled manned glider flights. With over 2,000 glides to his credit, Otto Lilienthal was well on his way to achieve powered flight. Tragically, he was killed in a glider accident before his work could progress further.

By the late 1800's, many others worked on gliders such as British inventor, Percy Pilcher and American, Octave Chanute. The world was knocking on the door of powered flight, but engines at the time were steam driven, making them much too heavy for use in an airplane, but still they tried.

## Powered Flight

Clement Ader and Sir Hiram Maxim both built steam powered airplanes, but both were unsuccessful. In 1896, Samuel P. Langley, an American scientist, built and flew a small steam powered model called the *aerodrome*. Flying over 1/2 mile, he showed the world that powered flight was possible. Soon, gasoline engines became available that were lighter and more powerful than those of steam. Langley built a full sized aerodrome powered by a gasoline engine. Two flight attempts were made, one on Oct. 7, 1903 and the other on Dec. 8, 1903, but both were failures.

On Dec. 17, 1903, two American brothers shook the world. At Kill Devil Hill, near Kitty Hawk, North Carolina, Orville and Wilbur Wright successfully flew their airplane named the *Flyer*. With Orville at the controls, their *Flyer* flew for 12 seconds covering a distance of 120 feet. Three more flights were made that day with each of the brothers taking turns at the controls. Wilbur piloted the longest flight of 59 seconds for a distance of 852 feet. The Wright *Flyer* was a biplane with a 12 horsepower gasoline engine powering 2 propellers. Instead of wheels, the *Flyer* was launched from a 60 foot rail and landed on wooden skids. But, more significant, the *Flyer* could be controlled. Using a system of cables to twist or warp the wings, the pilot could maneuver the airplane in flight. The airplane was born!

From that day, other aviators followed and the airplane was put to work. During WWI, the airplane was used initially for observation of enemy troops, but soon was equipped with machine guns and bombs. After the war, daredevil pilots known as barnstormers entertained crowds with aerial stunts. During the post war years, the airplane found little application until the U.S. government started mail service with airplanes. Soon the world discovered the practicality of air travel and companies started producing large airplanes for passenger and cargo service. WWII put the airplane to use for military operations and aviation technology advanced rapidly. By the end of the war, jet aircraft were developed leading the way for today's jetliners. In the short span of under 100

years, as compared to the time from 3500 BC to 1903, aviation advanced from a small wood and cloth airplane flying 120 feet to supersonic jets and the space shuttle capable of flights into earth orbit and back. We have always had the desire to fly and possessed the mental capability to rationally approach the subject, but obviously technology needed to reach a point to make flight possible. One factor and probably the most significant one in the delay of technological advancement is communications. Until forms of mass communications were available, such as newspapers, radio and mass produced books, discoveries by an individual in one part of the world would be unknown by another elsewhere. Inventors were experimenting in aviation without the advantage of knowing what research had already been performed. For the most part, each worked independently of each other, duplicating their efforts. The lack of communication significantly delayed the conquest of flight.

## SANDS OF AVIATION TIME

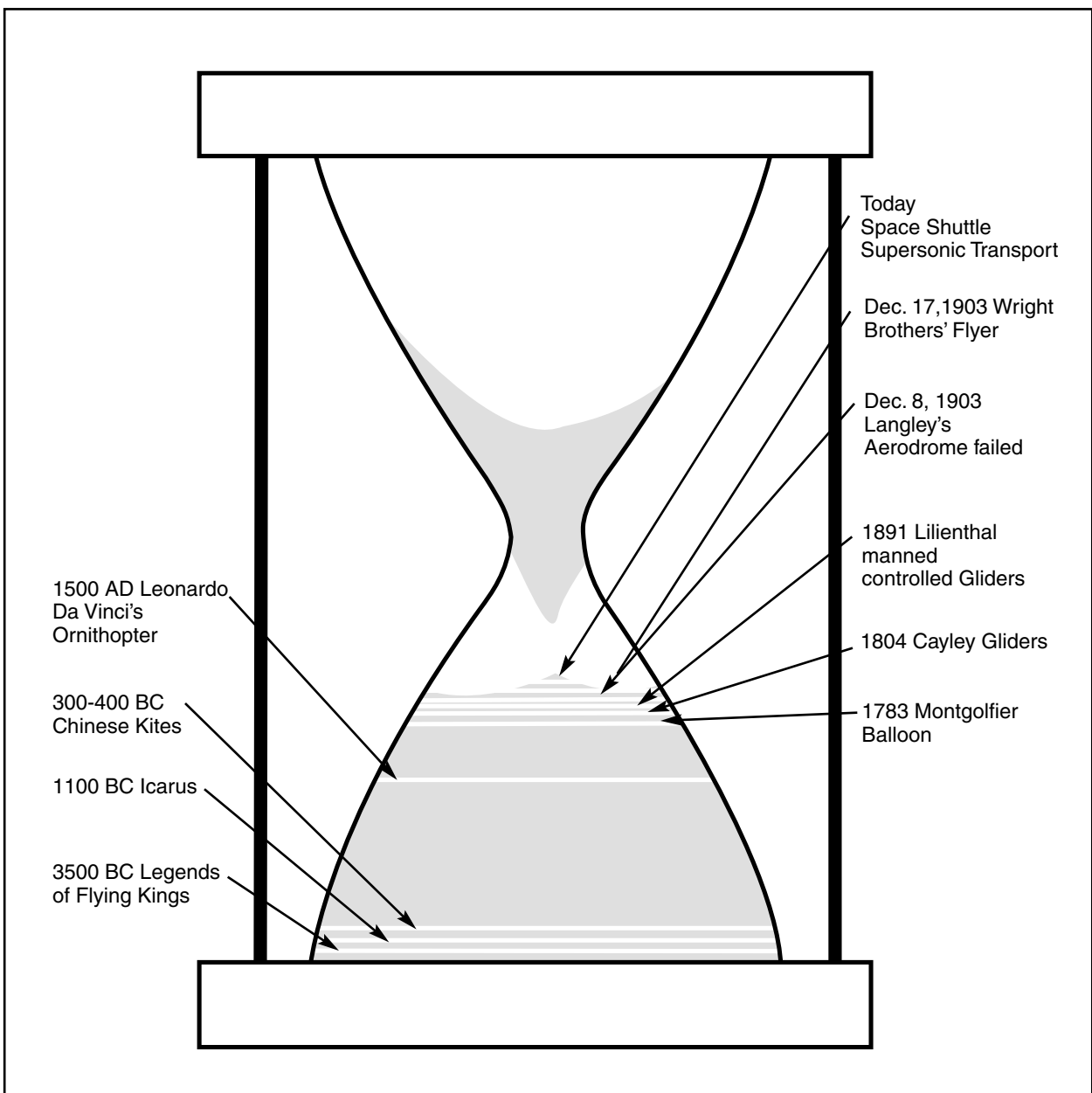



## Vocabulary

**Airplane:** An aircraft, heavier than air, that sustains flight in the air using an engine.

**Balloon:** A bag that floats in the air when filled with hot air or gas which is lighter than air.

**Buoyant:** The ability of an object to float in a liquid or air.

**Glider:** An aircraft, heavier than air, that flies through the air without an engine.

## Strategy

**Materials Needed:** Colored pencils or crayons

**Motivation:** Make a simple paper airplane and fly it in the classroom. See how many students have flown a paper airplane, then tell them the paper glider you made took the human race over 4,000 years to develop. Ask your students how flight was possible before the invention of the airplane and see how many ideas are generated.

**A.** Using Activity Sheet #1A, discuss ancient aviation folklore, then have students fill in data and color each related picture in order of presentation.

### **Icarus & Daedalus**

Greek mythology; 1100 BC  
Escaping from Crete  
Made wings of feathers, thread and wax  
Icarus flew too high  
Sun melted wax  
Icarus fell and drowned

### **Chinese kites**

300-400 BC  
First real evidence of flight  
Application of flight

### **Archimedes' Principle**

200's BC  
Archimedes; Greek mathematician and inventor  
Materials lighter than water will float in water  
Didn't apply the principle to air

### **Ornithopter**

Leonardo Da Vinci, 1500 AD; Italian inventor and artist  
Detailed sketches of wing flapping flying machines  
Scientific approach to flight  
Flying toy models based on this design fly today

**B.** Using Activity Sheet #1B, discuss the evolution of balloons, then have students fill in data and color each related picture in order of presentation.

### **Montgolfier**

French brothers; paper makers  
First manned flight, 1783  
Paris, France  
Hot air balloon made of linen and paper  
Altitude 300', Range 5 miles  
Archimedes' principle of buoyancy

### **Civil War Balloon**

1860's  
Directing artillery fire  
Observing troop movements  
Hydrogen filled

### **Zeppelin**

Ferdinand von Zeppelin; German inventor  
Manageable  
Gas engine propelled  
Commercial travel and cargo  
WWI weapon applications

### **U.S. Military**

Patrol coastline  
Reconnaissance  
Searching for submarines

### **Sport Balloons**

Colorful  
Hot air using propane burners  
Modern technology using 200's BC principles

**C.** Using Activity Sheet #1C, discuss the evolution of gliders, then have students fill in data and color each related picture in order of presentation.

### **Sir George Cayley**

Englishman  
1804; first unmanned glider (small model)  
First to carry a human passenger  
Foresaw gliders with engines to propel them

**Otto Lilienthal**

German engineer

1891- 1896; over 2,000 glides

First to build and fly a glider controlled in flight by a pilot

**Octave Chanute**

American inventor

Invented the biplane (double wing) glider

**D.** Using Activity Sheet #1D, discuss the evolution of powered flight, then have students fill in data and color each related picture in order of presentation.

**Aerodrome**

1896; Samuel P. Langley

Built and flew a steam powered model airplane

Built full sized manned airplane, but failed to fly; Oct. & Dec. 1903

**Wright Brothers**

First powered manned airplane

December 17, 1903

Kill Devil Hill, near Kitty Hawk, North Carolina

First flight, 12 seconds, 120 feet

**E.** Using Activity Sheet #1E, discuss the progress of aviation since the Wright brothers and color each related picture in order of presentation. Reinforce how rapidly aviation has progressed since the invention of the airplane.

1917 WWI fighter

1936 DC-3 transport plane enters airline service

1947 Bell X-1; first supersonic airplane (rocket powered)

1970 Boeing 747; passenger jumbo jet

1979 F-16; Mach 2 (twice the speed of sound) jet fighter

Today Space Shuttle

Future VentureStar

**Closure:** Review the "Sands of Aviation Time" to summarize the aviation events since 3500 BC.

## Notes

## Lesson 2 (Two Days)

### The Airplane

#### Objective of the Lesson:

#### The student will be able to:

- \* Explain how a wing creates lift
- \* Identify the components of an airplane
- \* Explain the functions of each airplane component
- \* Explain how motion about each axis is created
- \* Identify the four forces acting on an airplane
- \* Explain how the flight controls and control surfaces cause an airplane to maneuver

#### Background for the Teacher

##### A. Components

Since the beginning of powered flight by the Wright Brothers at Kitty Hawk, NC in 1903, airplanes have evolved rapidly. We fly faster, higher and carry more weight than was ever imaginable. But, even with all the technical advancements, the vast majority of airplanes today still have the same general form as shown.

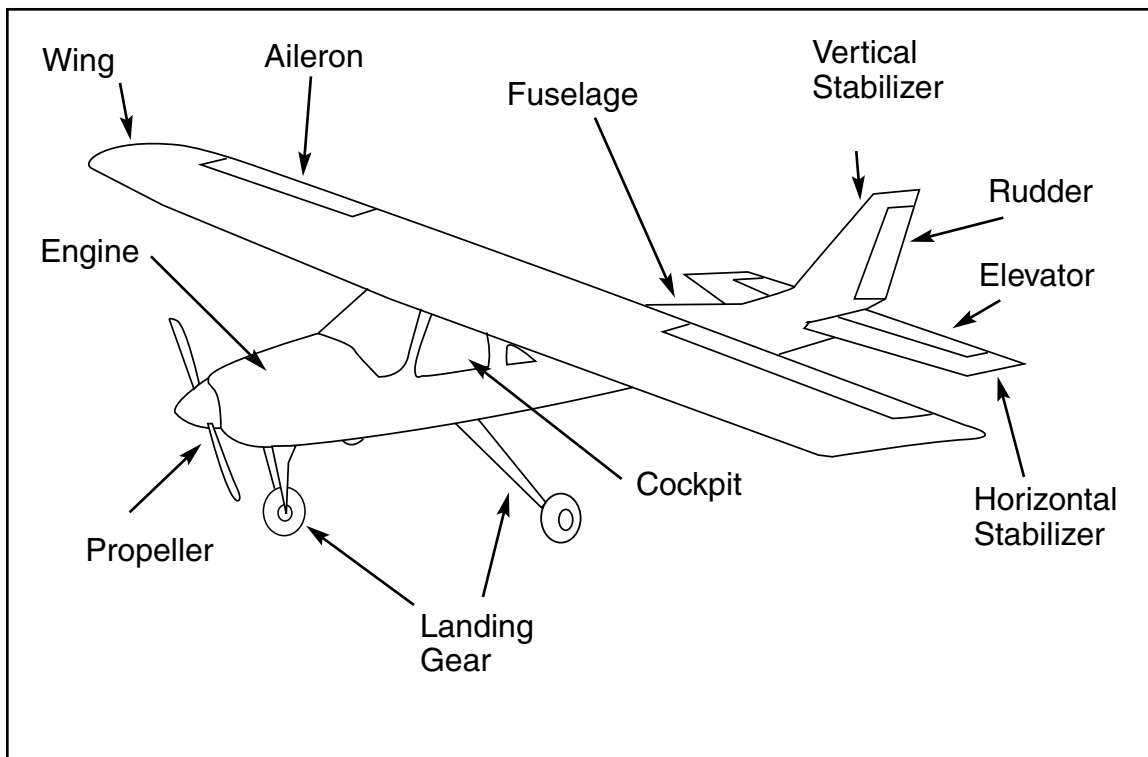

Let's review each of these parts in detail and examine how they work.

## Wing

The wing is the most easily recognizable part of the airplane and is responsible for generating a force called *lift* that causes the airplane to rise. As you saw in the history portion, the wing was the most difficult part of the airplane to invent. Inventors tried to copy the wings of birds, as can be clearly seen in early flight attempts, but truly didn't understand the principles involved. To understand how a wing produces lift, we must first study the works of the famous Swiss mathematician and scientist, Daniel Bernoulli.

Look at the second picture below that shows water flowing through a special pipe that changes diameter. Bernoulli built a pipe like this and attached pressure gauges at the locations shown, then pumped water through it to examine how the water pressure would change. The cross sectional area of section A is larger than the cross sectional area of section B. Since equal volumes of water must pass through both sections simultaneously, the water flowing through the smaller section B, must be traveling faster than section A.

The students have probably experienced this for themselves while playing with a garden hose.

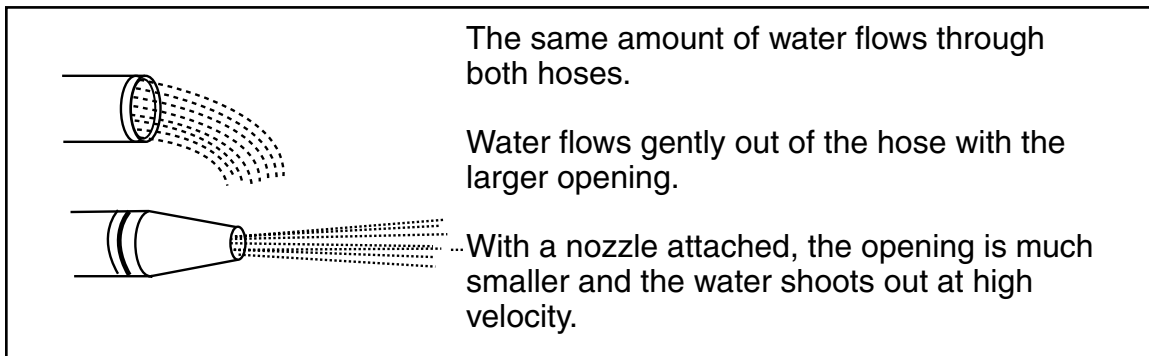

When Bernoulli read the pressure gauges, he found that the pressure at section B was less than the pressure at section A.

So, he discovered that:

As the speed of a fluid increases, the pressure decreases, and

As the speed of a fluid decreases, the pressure increases.

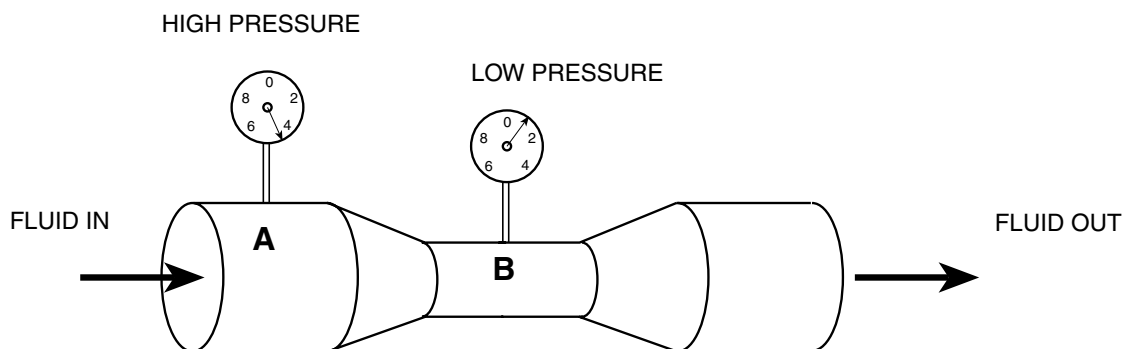

A wing produces lift using the same principle. Instead of a pipe, we use an airfoil. An airfoil is the cross sectional shape of a wing if you cut through it. A typical airfoil is shown on the next page. The upper camber of the airfoil changes the flow pattern of the air across it, like the garden hose nozzle changes the flow pattern of the water

through it. The shape of the upper camber acts as a constriction in the air flow, reducing the cross sectional area for the fluid to flow through, just like the garden hose nozzle. Since the volume flow rate of air starting across the top surface at the leading edge must be equal to that at the trailing edge, the airflow velocity in between must increase. The result is higher velocity across the upper camber and lower airflow velocity across the lower camber.

Now here comes Bernoulli's principle.

Since the air travels faster across the top of the wing than the bottom, the air pressure on top of the wing is less than the air pressure on the bottom. The high pressure tries to flow to the low pressure, pushes on the wing and generates LIFT !

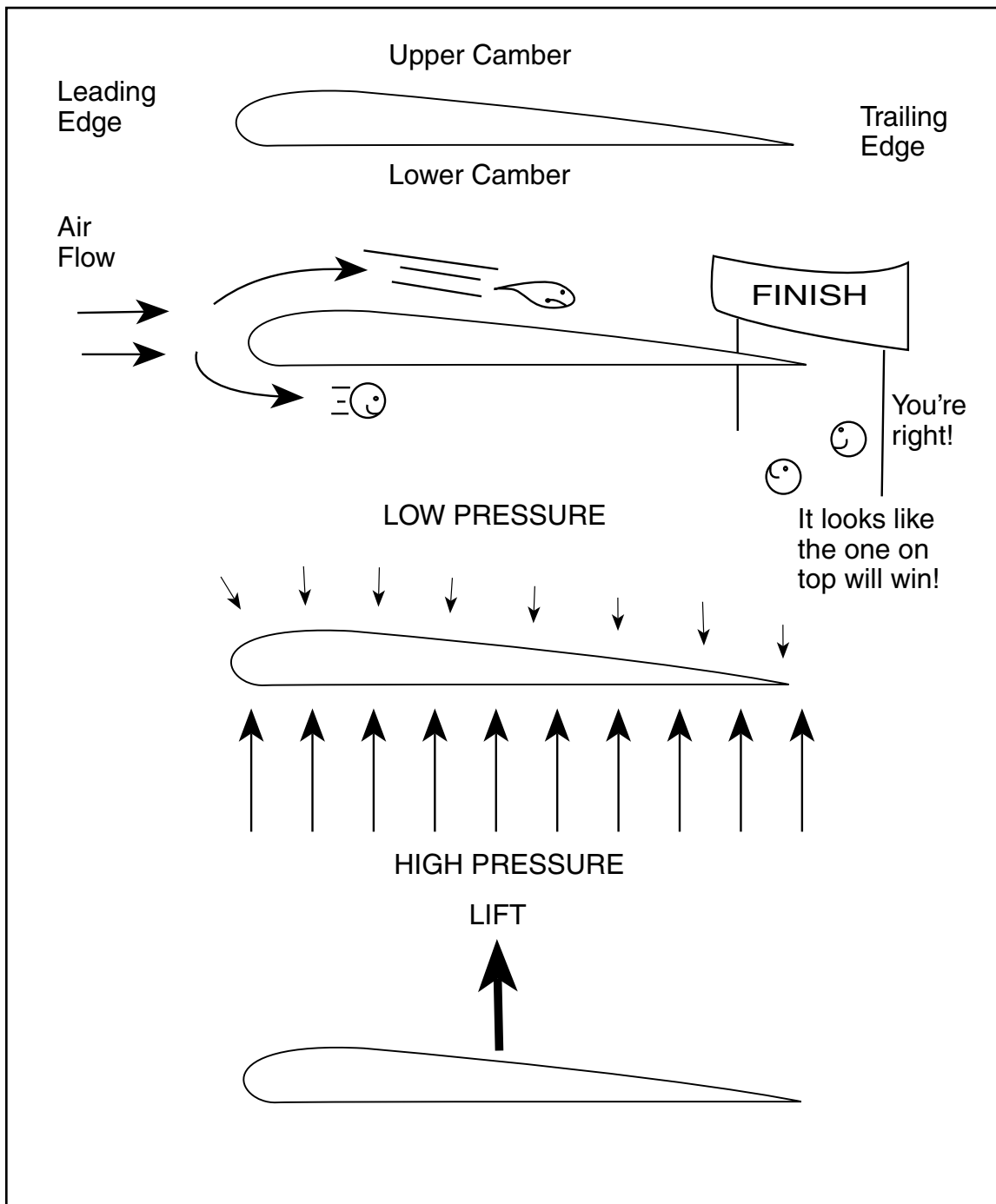

A simple demonstration of this phenomenon can be performed using a sheet of notebook paper.

As you will see, this principle of generating lift is used in numerous parts of the airplane. Let's look at some of the others.

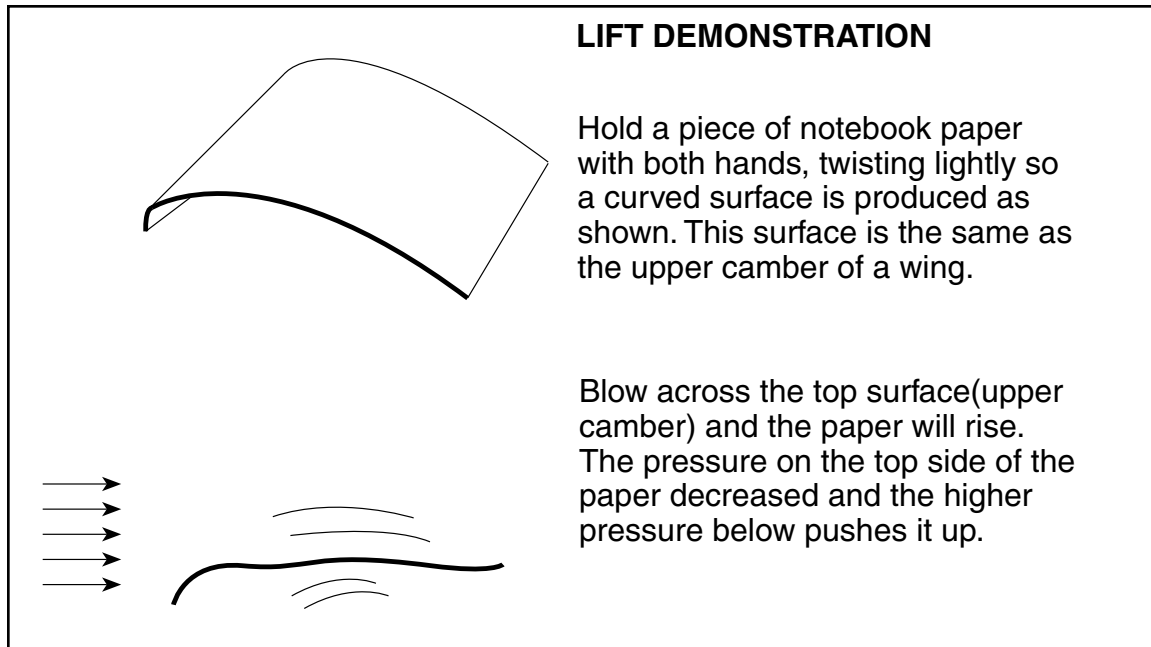

### Vocabulary

**Horizontal Stabilizer:** This piece is a small wing that produces lift. It is responsible for stabilizing the airplane so the nose of the airplane doesn't pitch up and down. It gets its name because it is horizontal, just like the horizon.

**Vertical Stabilizer:** This piece is also a small wing that produces lift. It stabilizes the airplane so the nose doesn't yaw left or right. It gets its name because it is vertical.

**Elevator:** The elevator is connected to the horizontal stabilizer and is controlled by the pilot to move up and down. The horizontal stabilizer along with the elevator form a small wing. As the elevator moves up or down, it changes both the shape of the small wing and the direction of lift produced, causing the airplane's nose to move up or down.

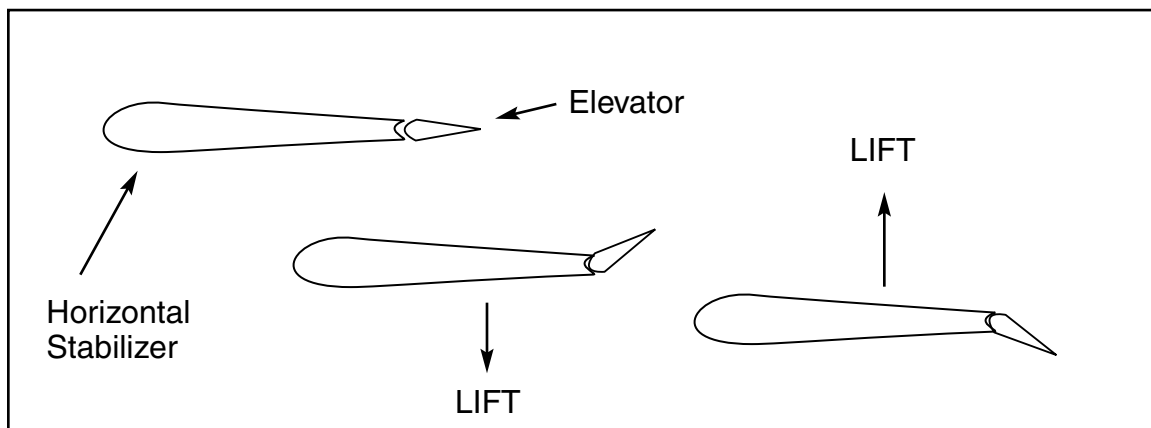



**Rudder:** The rudder is connected to the vertical stabilizer and is controlled by the pilot to move left and right. The vertical stabilizer along with the rudder form another small wing. As the rudder moves left or right, it changes the lift produced and causes the nose of the airplane to swing (yaw) left or right. The diagram for the elevator is identical to the rudder, except it would be viewed from above instead of the side.

**Aileron:** The ailerons are connected to the wing and are controlled by the pilot to move up or down. Just like the elevator and rudder, it changes the lift produced by the wing and causes the airplane to roll. The ailerons ( one at each end of the wing) move in opposite directions from each other.

**Engine:** The engine produces power to make the airplane move. In our diagrams, the engine turns a propeller which produces thrust. Other airplanes use jet engines that don't use propellers.

**Propeller:** The propeller is connected to the engine and spins very fast to produce thrust. If you have an electric fan at home, you have seen a propeller in action. They work the same.

**Landing Gear:** Just like a car, an airplane needs wheels so it can move around on the ground. The aviation term used is called *taxi*. The airplane will taxi to the runway for takeoff and will taxi back to the hangar after landing.

**Fuselage:** The fuselage is the main structural part of the airplane that connects all the other parts together. It acts just like your body. Your arms, legs and head are attached to your body. The wings, stabilizers and engine are connected to the fuselage.

**Cockpit:** The cockpit is the part of the airplane where the pilot sits and flies the airplane.

Now that we know the various parts of the airplane, let's see how these parts work together and make the airplane fly.

## B. Aerodynamics

### Motion about the Axes:

In some ways a car is much like an airplane. A car can move forward (and backwards) and make turns to the left and right. An airplane can also move forward and make turns to the left and right. What makes an airplane different is that it can also move up and down. An airplane has three axes for motion, whereas a car only has one. The diagram below shows how an airplane moves about these three axes. When an airplane changes its attitude (motion about one or more axes), it rotates about the *center of gravity*. The center of gravity is the balancing point of the airplane.

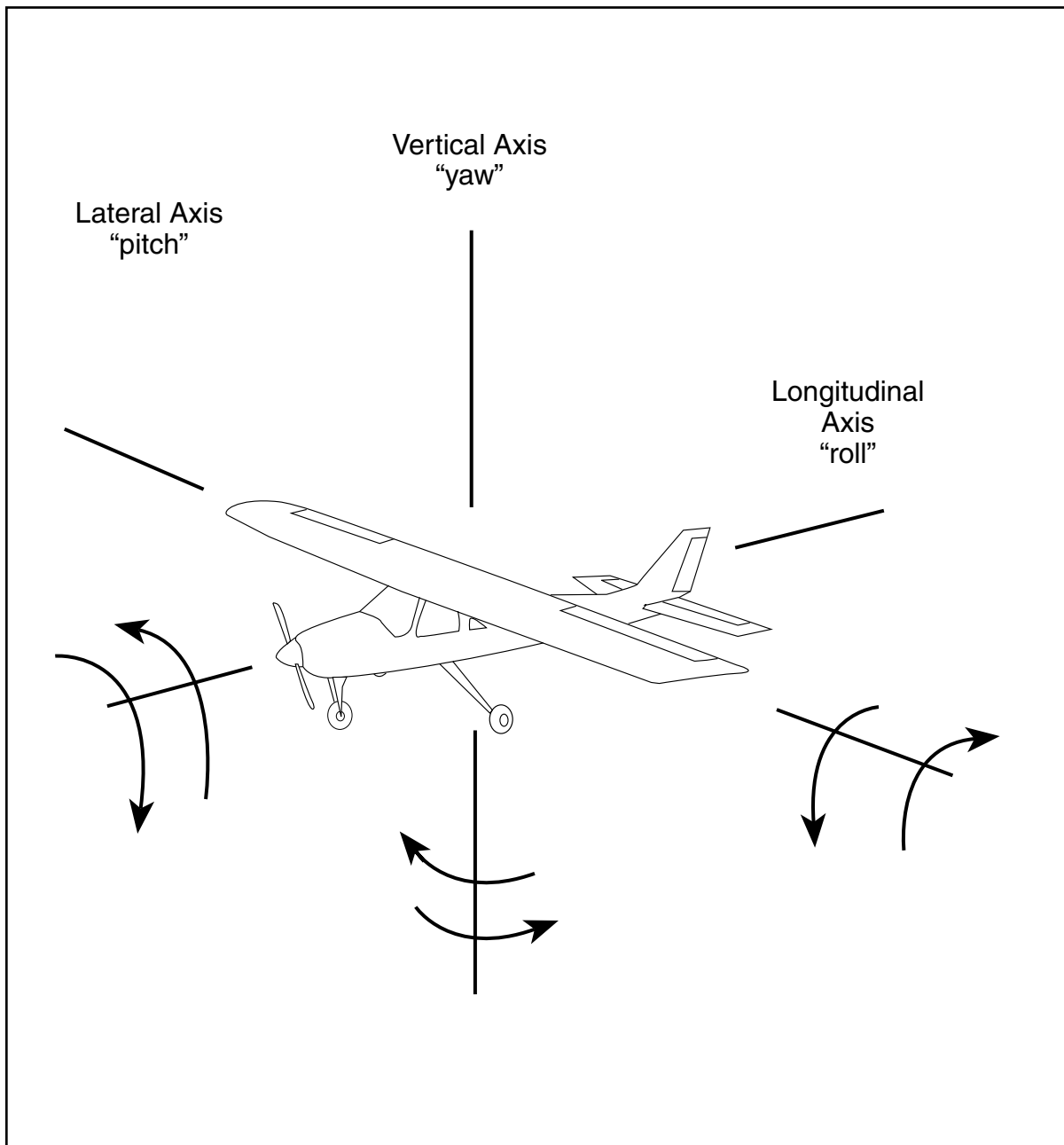

Motion about the lateral axis (pitch) is caused by movement of the elevator. When the elevator moves down, the stabilizer and elevator form an airfoil that produces lift causing the tail to rise. The airplane pivots about the center of gravity and causes the nose to go down. The airplane is now in a dive. When the elevator deflects up, the opposite occurs, forcing the nose up and the airplane is now in a climb.

Motion about the vertical axis (yaw) is caused by the movement of the rudder. When the rudder moves right, it forces the tail to the left and the nose yaws to the right. When the rudder is deflected left, the opposite occurs and the tail moves to the right which yaws the nose to the left. The principle is identical to the elevator.

Motion about the longitudinal axis (roll) is caused by the ailerons. An airplane uses two ailerons to control the movement and they work in opposite directions. When a pilot wants to roll the airplane to the right, the left aileron goes down and the right aileron goes up. Each aileron creates lift in opposite directions, causing the airplane to roll. To roll left, the left aileron goes up and the right one goes down. The students can experience this for themselves. Have a student stand up with arms rigidly extended out like the wings of an airplane. Have one student gently push down on one arm as another student pushes up on the opposite. The student will feel the rolling motion created.

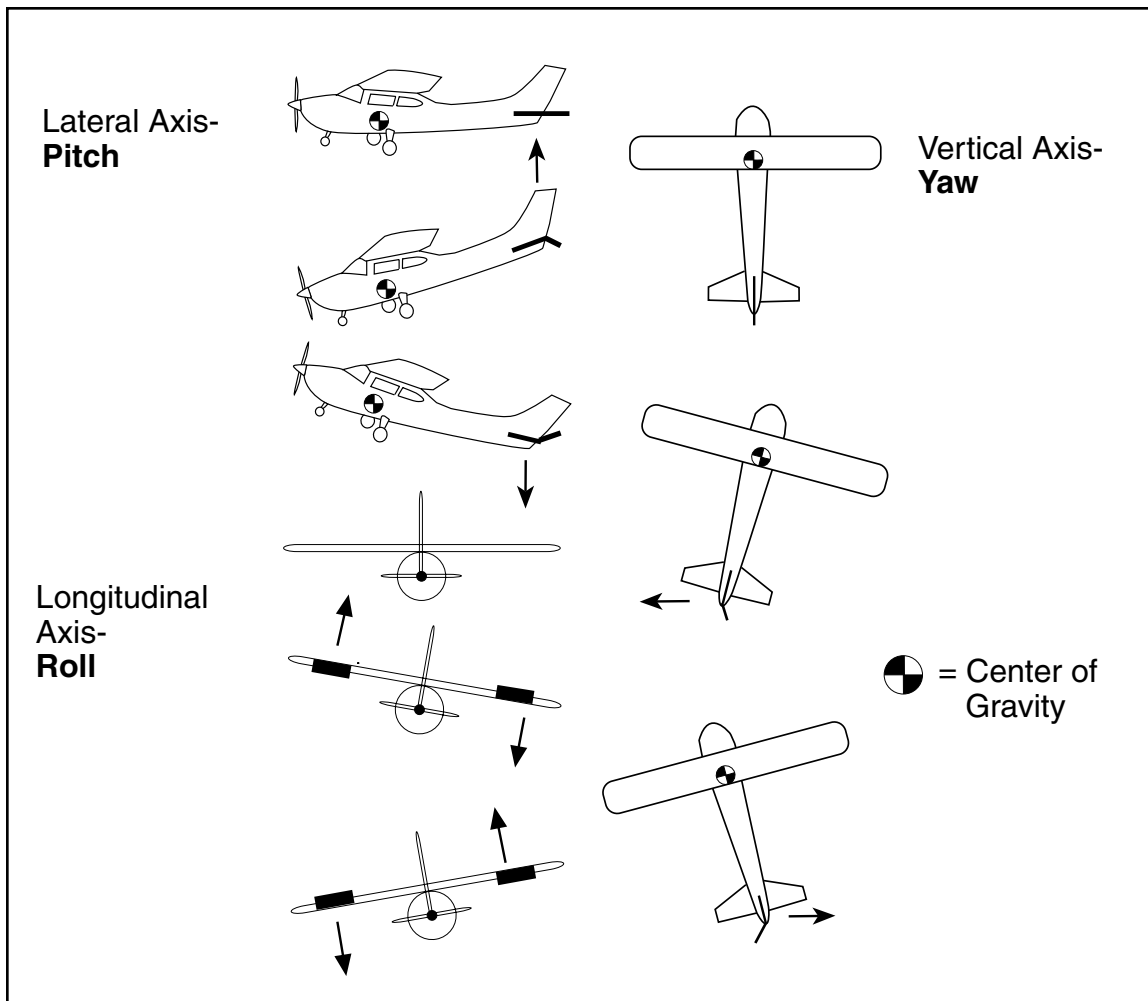

## Forces on an Airplane:

When an airplane flies, it is under the influence of four primary forces: lift, weight (gravity), thrust and drag. We have already studied lift and should have a good understanding of how it is produced. The purpose of lift, however, is to hold the airplane up in the air by countering the effects of weight (gravity).

Airplanes are built of different sizes and weights. Some are as light as a few hundred pounds and others weigh several hundred thousand pounds. In order for an airplane to leave the ground and fly, the lift produced by the wing must be equal to or greater than the weight of the airplane. As you can see from the diagram, lift and weight (gravity) oppose each other.

A new term to study is *drag*. Drag is a force that impedes the forward motion of an airplane. As an airplane flies, it must push its way through the air. You wouldn't think that air could offer much resistance, but it does. On a windy day, stand outside and try to hold a large piece of cardboard into the wind. You will find it very difficult to stand without being pushed around. The wind is trying to flow around both you and the cardboard and the force you feel is drag. Another example of drag is trying to walk quickly through water in a swimming pool. It is very difficult and you can't go very fast. An interesting note about drag is that the force changes with velocity. As the speed of an airplane increases, the amount of drag generated increases too. The diagram below gives an example of this concept. To reduce the effects of drag, you need to streamline the object that is in motion. The streamlined shape of an airplane is to make it easier to slip through the air. The force that opposes drag is *thrust*.

As you remember from earlier discussions, thrust is produced by the spinning propeller. To keep a plane flying, you must produce enough thrust to counter the force of drag. If the thrust is less than the drag, the airplane will slow down. If the thrust is higher, it will speed up. If the thrust and drag are equal, the airplane will fly at constant velocity.

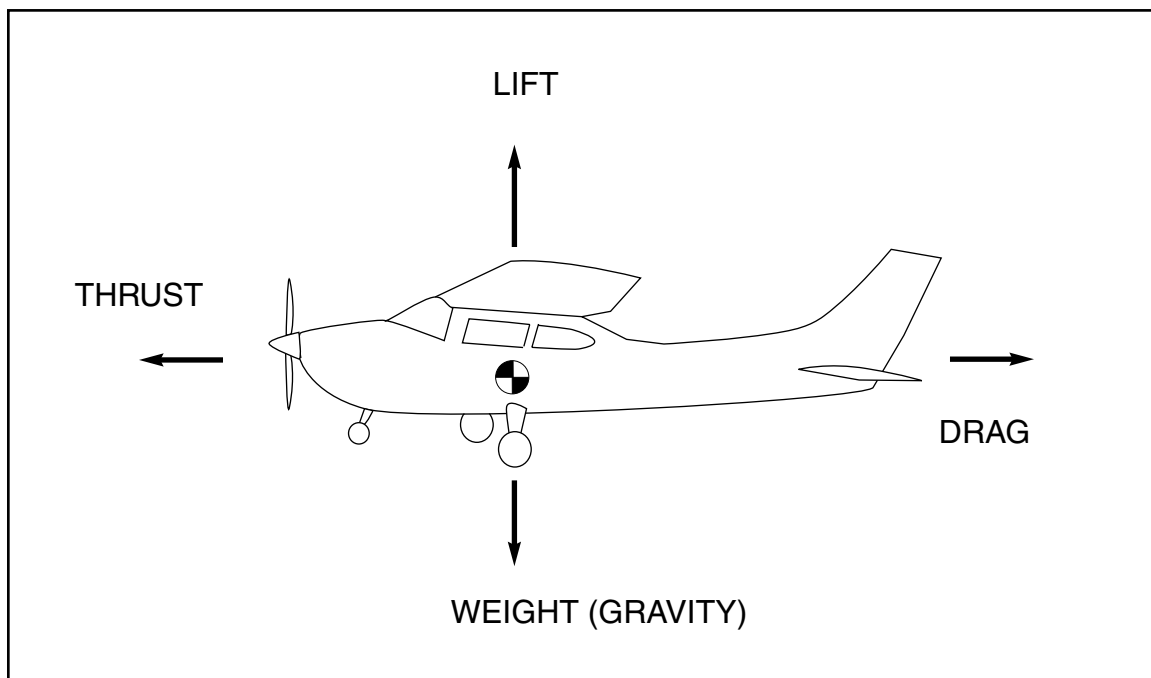

## Maneuvering:

When an airplane is flying straight and level at a constant speed, all four aerodynamic forces are in equilibrium. Thrust equals drag and lift equals weight (gravity). You can now apply all previous material and see how airplanes maneuver.

By moving the flight controls, the pilot moves the control surfaces (elevator, ailerons and rudder) to change the attitude of the airplane. The thrust then moves the airplane in this new direction as shown in the following diagrams.

A level turn is a combination of motion about the vertical and longitudinal axis. An airplane could make a turn by yawing about the vertical axis as shown in prior diagrams, but it is uncomfortable for the pilot and passengers. You have felt this type of turn

## CLIMBS AND DIVES

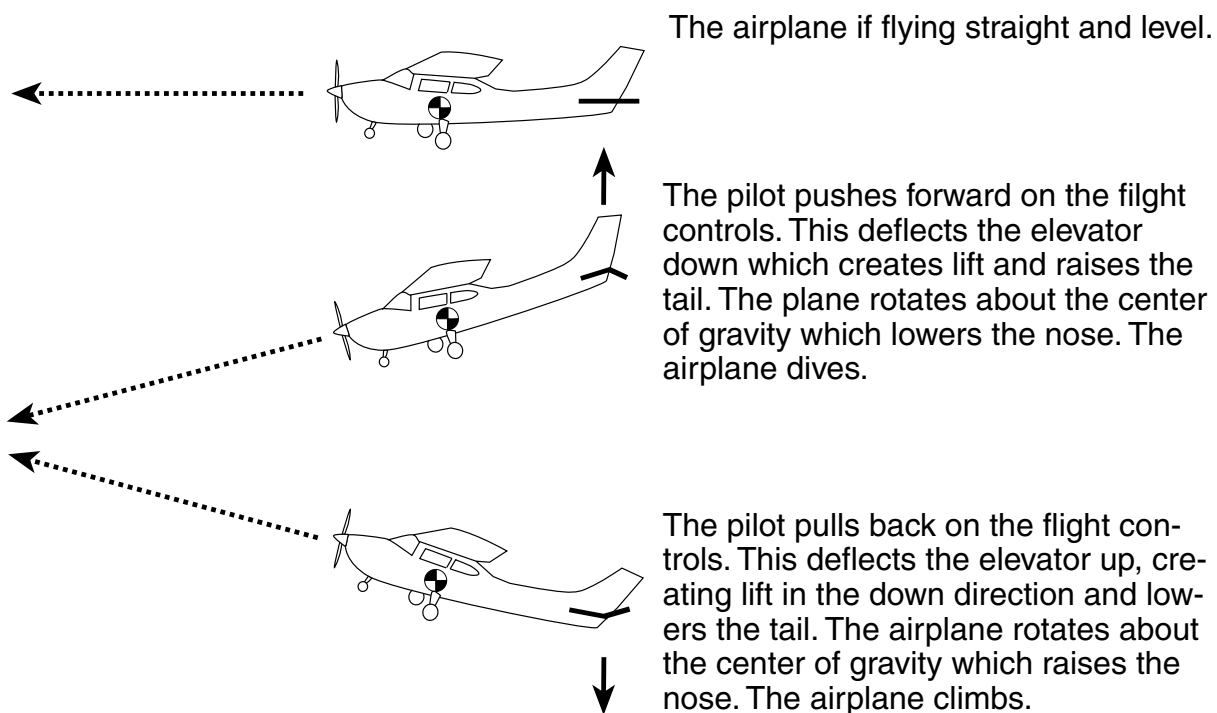

before in your car. If you make a turn on a level road, you feel your body being thrown to the outside of the turn. It is difficult to sit upright. The faster you go and the tighter the turn, the worse the effect is. Race car drivers know this so the tracks they race on are banked. This banking makes it easier to stay in the turn without skidding off the road. Airplanes do the very same thing. When they make a turn, the rudder is deflected in the direction of the turn and the wings are *banked* in the direction of the turn. This is called a coordinated turn.

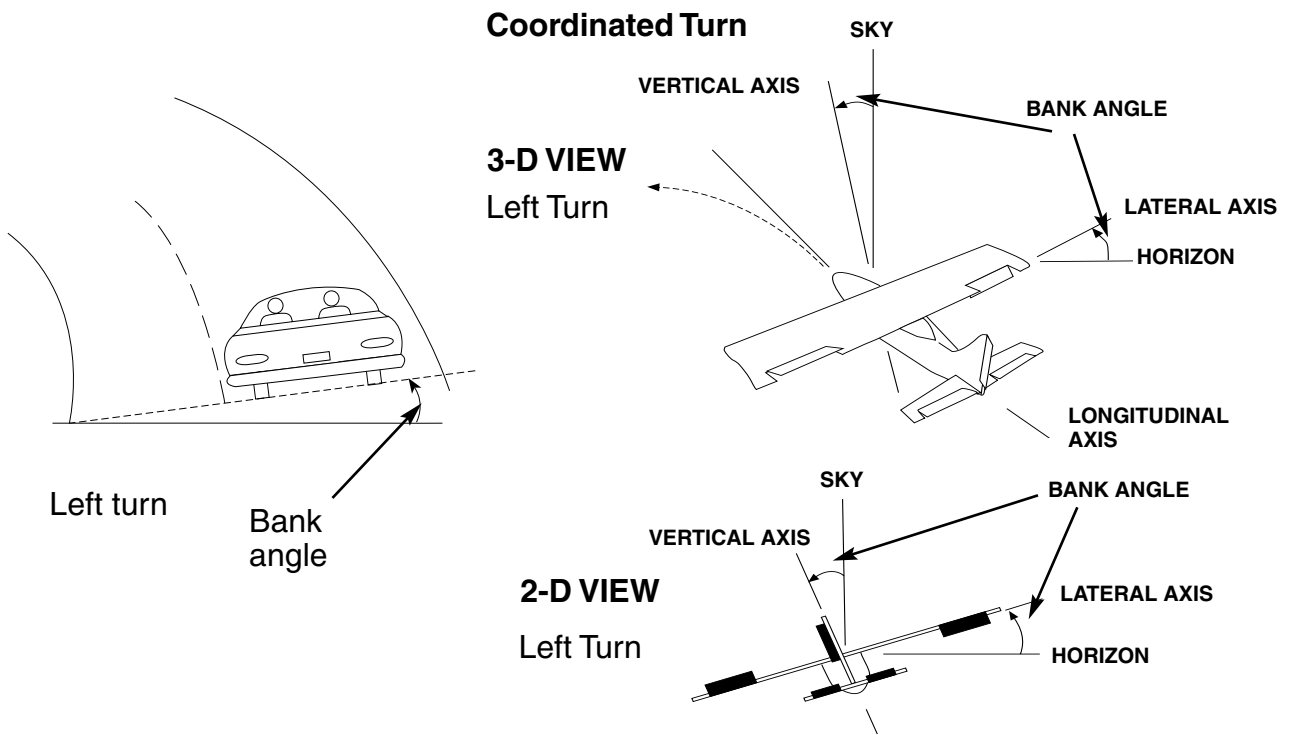

When an airplane flies, the pilot uses a combination of climbs, dives and turns to maneuver the airplane. Even take-off and landings use these simple maneuvers. For take-off, the pilot taxis out to the runway. The pilot throttles the engine up to full power to produce the maximum thrust possible. Because the thrust is greater than the drag, the airplane accelerates down the runway, gaining speed, until it is traveling fast enough to fly. The pilot then initiates a climb and the airplane leaves the runway. For landing, the pilot starts a gentle (shallow) dive towards the runway. As the airplane gets close to the runway, the pilot brings the throttle back to idle, so the thrust is less than the drag. The airplane slows down and the pilot lands the airplane. The long runway allows the airplane to decelerate to a speed where the pilot can then taxi the plane back to the hangar.

### Flight Controls:

You now know how an airplane flies, but how does the pilot command the air-

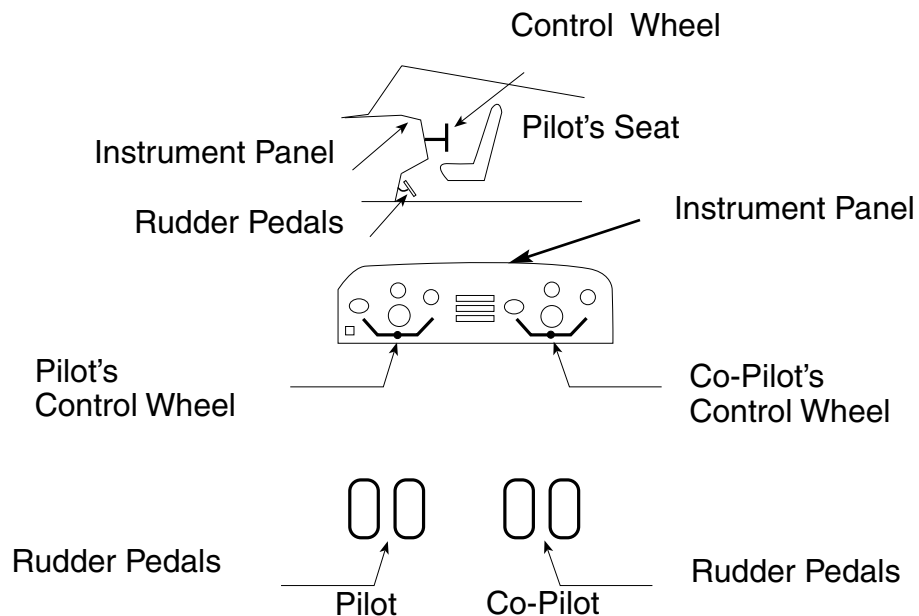

plane to do what it does. That is accomplished through the flight controls. Inside the cockpit, the pilot has a set of flight controls that move the ailerons, elevator and rudder.

The control wheel (also called the yoke) moves the elevator and ailerons. Pulling on the control wheel deflects the elevator up (climb) and pushing on it deflects it down (dive). Turning the control wheel left commands the left aileron up and the right aileron down (left roll) while turning the control wheel right commands the right aileron up and the left aileron down (right roll).

On the floor of the cockpit at the pilot's feet are two rudder pedals. Pushing the right one commands the rudder right (right yaw) and pushing the left one commands the rudder left (left yaw).

### **Flight Controls Vocabulary**

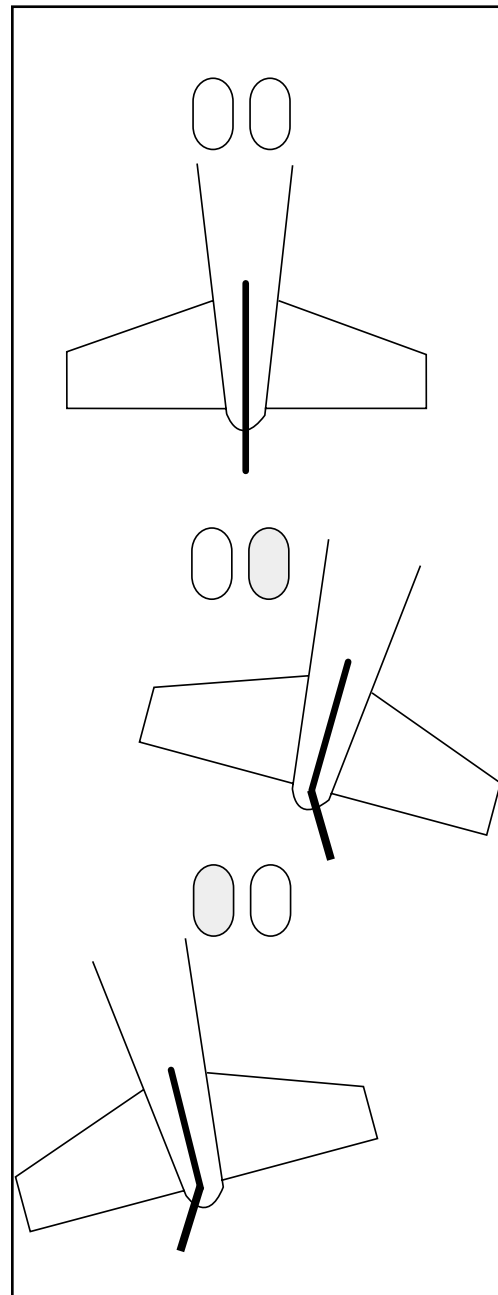
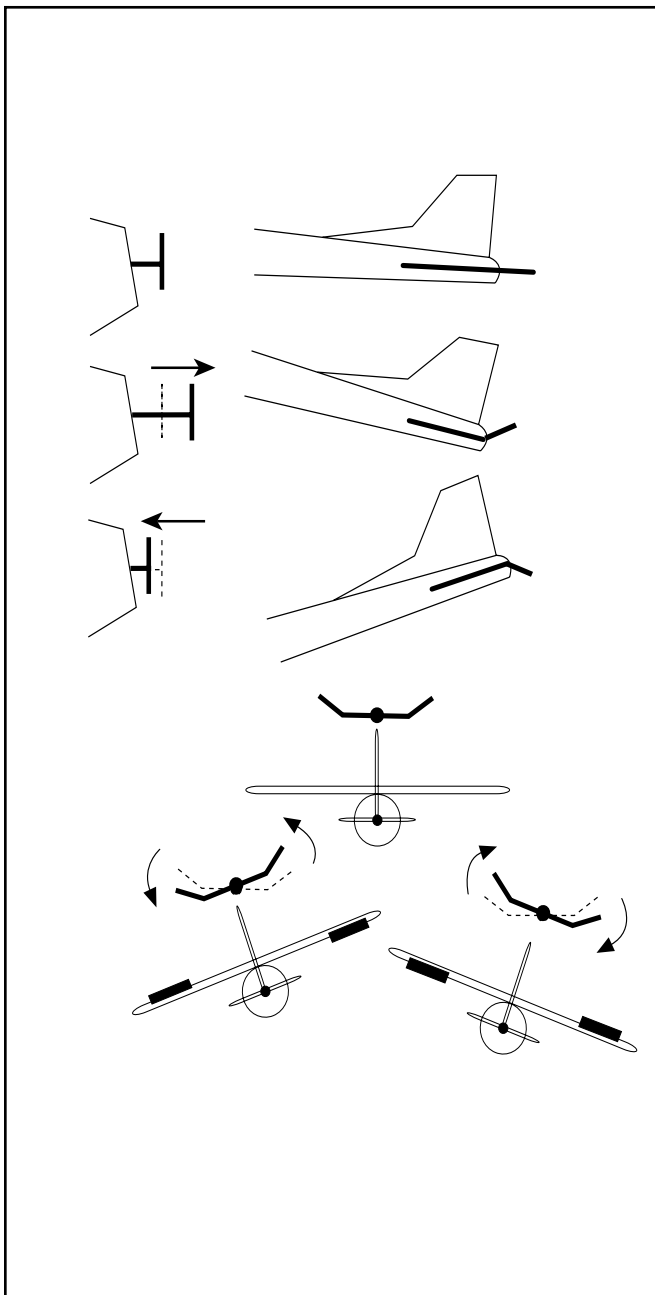

**Aileron:** A control surface attached to the wing causing it to roll left or right.

**Bank:** An aviation term to indicate the rolling motion of the wings, left or right.

**Cockpit:** The area inside an airplane where the pilot and co-pilot sit.

**Drag:** A force created by the airflow around the airplane, impeding its forward motion.

**Elevator:** A control surface creating pitching motion, resulting in climbs and dives.

**Engine:** Provides power to spin the propeller, propelling an airplane forward.

**Flight Controls:** Mechanical devices positioned by the pilot to move the control surfaces.

**Fuselage:** The main body of an airplane where most other parts are attached.

**Leading Edge:** The forward edge of the wing.

**Lift:** A lifting force created by the wing which carries an airplane in the air.

**Pitch:** The up and down movement of an airplane's nose about the lateral axis.

**Propeller:** Spinning device attached to the engine which creates thrust for forward motion.

**Roll:** Rotating motion of an airplane about the longitudinal axis, created by the ailerons.

**Rudder:** A control surface creating yaw, swinging the aircraft's nose left or right.

**Thrust:** The force created by the propeller, causing forward motion.

**Trailing Edge:** The rear edge of the wing.

**Wing:** The airplane part that generates lift to fly.

**Yaw:** The left and right swinging motion of the aircraft's nose about the vertical axis.



## Strategy

### Day One

**Materials Needed:** Student activity sheets  
Transparencies of student activity sheets  
Overhead projector  
Pencils for students  
Crayons or colored pencils for students

**Motivation:** Ask your students to guess how much a jumbo passenger jet weighs. Tell them they can weigh over 200,000 pounds! That's equivalent to about 80 large automobiles. Ask them how it's possible for a heavy metal object like that to fly without enormous rocket motors under it to push it into the air. In this lesson, they will learn how the air about them is used to lift airplanes into the air.

- A. Using a transparency of Student Activity Sheet #2A and an overhead projector, have each student label the components of an airplane.
- B. Make a sketch of a garden hose on the blackboard and show how changing the size of the opening changes the velocity of the water coming out. Using a transparency of Student Activity Sheet #2B and an overhead projector, explain Bernoulli's principle. Have the students fill in the blanks about the pressure changes with velocity. Using Student Activity Sheet #2C, explain the principle of lift generated by a wing. Emphasize how the airflow across the upper camber is faster than that across the lower camber. Have students fill in the blanks where applicable.
- C. Now that the theory of lift has been explained, demonstrate the principle using the lift demonstration explained earlier in this lesson. Have each student hold their Student Activity Sheet with both hands, forming a curved surface. Show them that this is the same shape as a wing. Each student should blow across the upper surface (upper camber) and observe the paper rise due to the pressure differential.
- D. After your students understand how lift is generated by a wing, go back to Student Activity Sheet #2A and explain the function of each component so the students can fill in the blanks.
- E. To wind down Day One of this lesson, have the students complete Student Activity Sheet #2D and color.

## Day Two

**Materials Needed:** Student activity sheets  
Transparencies of student activity sheets  
Overhead projector  
Airplane model (Estes Hi-Lite®) - optional  
Paper airplanes for students - optional  
Pencils for students

**Motivation:** Before Orville and Wilbur Wright successfully flew the first airplane, they didn't have anyone to teach them how to fly it. Today's lesson would have made it much easier for them prior to their historical flight. The students will learn what controls an airplane and how the pilot flies it. After this lesson, they will know more about aerodynamics than the early aviation pioneers.

A. Using a model airplane (optional) with transparency of Student Activity Sheet #2E, explain the three axes of motion. Students can visualize this better if each has their own model (paper airplane). Have them fill in the blanks as you present the material.

B. Using a model airplane (optional) with transparency of Student Activity Sheet #2F, show how the control surfaces cause motion about the three axes. Have each student sketch in the deflected shape of each control surface.

C. Explain the four forces acting on an airplane in flight. Using Student Activity Sheet #2G, have the students label the forces as they are presented. After the diagram is completed, have an open discussion about the effect each of the forces would have if not in balance, i.e., if drag was less than thrust, what would happen? ... if weight (gravity) was greater than lift?

D. Explain how an airplane climbs and dives. Now that they see how an airplane's attitude is changed by, in this case, the elevator, the climb or dive is forward motion at the new attitude. Have the students complete Student Activity Sheet #2H by sketching in the elevator movement.

E. To explain what a coordinated turn is, first start with a level horizontal turn in a car. Using Student Activity Sheet #2I, show how the passengers in a car are pushed to the outside of a turn. To eliminate that, roads are banked. Airplanes do the same thing and bank in a turn. Instead of being pushed to the outside, the passengers are pushed down into the seat which is much more comfortable. On the activity sheet, show how both the ailerons and rudder are used for a turn and have the students sketch them in the correct position. Emphasize that turns in the opposite direction use the same control surfaces, but in the opposite direction.

F. With Student Activity Sheet #2J, review the typical layout of an airplane cockpit. Emphasize that all changes in aircraft attitude are commanded by the pilot through the control wheel and rudder pedals.

G. Show how the flight controls deflect the control surfaces, thus causing a change in attitude. Using Student Activity Sheet #2K, have the students sketch in the appropriate control surface movement.

H. Use Student Activity Sheet #2L as a game to review how a pilot actually causes an airplane to maneuver.

**Closure:** Review any questions regarding how lift is generated and how an airplane maneuvers. Tell your students that the principles they have just learned are the same that airline pilots, military pilots and private pilots learned in order to fly airplanes such as the Boeing 747, F-16 Jet Fighter or a Cessna 172.

## Notes

## Lesson 3 (One Day)

### THE AIRPORT

#### Objective of the Lesson:

#### The student will be able to:

- \* Identify the major parts of an airport
- \* Explain the purpose of each major part on an airport
- \* Recite the phonetic alphabet

#### Background for the Teacher

##### A. Airport Diagram

Airports come in many sizes. Small towns may have a local airport for the typical weekend flier with runways 2,500 feet long. At the other end of the spectrum, major cities like Chicago or Washington D.C. have airports handling large passenger jumbo jets with runways over 12,000 feet long. The diagram shown is an average airport catering to larger aircraft. Though not shown in detail, the major facilities are depicted.

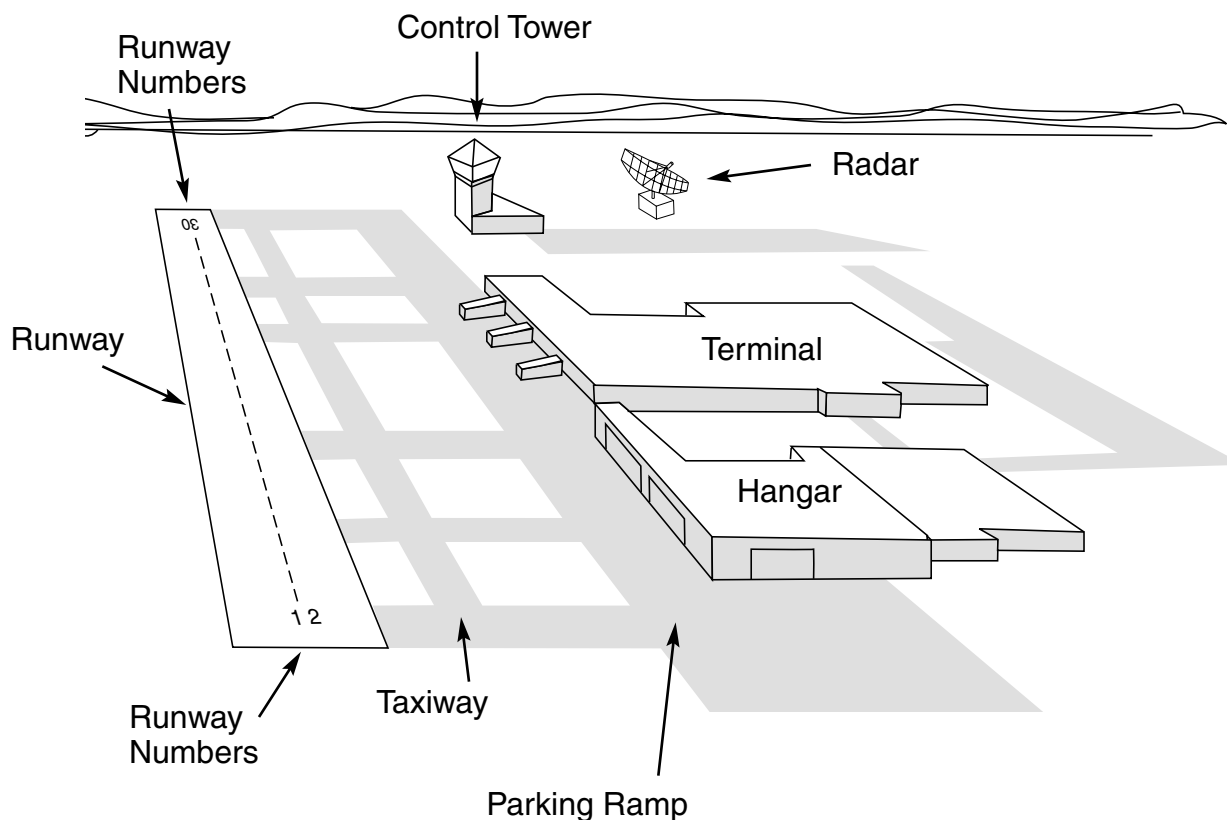

## **B. Facilities**

**1. Runway** - The runway is a long surface for airplanes to takeoff from and land. Large airplanes, like a commercial jetliner, need very long runways (10,000 to 12,000 feet long or more). Small airports will usually have only one runway, but large ones will have several to accommodate the large volume of traffic. One runway may be used for takeoffs only and another for landing. Other runways are available for when the winds change directions. Pilots always want to takeoff and land into the wind, so runways are constructed to account for the changing of prevailing wind conditions.

**2. Parking Ramp** - Airplanes, just like cars, need a place to park. Airports have large parking lots called parking ramps for the planes to stay when not flying.

**3. Taxiway** - Taxiways are streets or roads for airplanes to travel on to get between the parking ramp and the runway. When an airplane travels on the taxiway, the airplane is said to be taxiing. The airplane will taxi to the runway for takeoff and taxi to the parking ramp to park. A large airport will have a complex network of taxiways for airplanes to travel around the airport. In this case, taxiways are identified by letters and/or numbers just like streets having names.

**4. Terminal** - Commercial airlines use a building called the terminal to transfer people. The airliner will taxi to the terminal to load or unload passengers and their luggage.

**5. Hangar** - If an airplane needs to be repaired, it will be brought into the hangar to work on. It's just like an automobile garage, only much bigger. Sometimes, airplanes will be brought into the hangar to protect them from bad weather, such as hail or snow.

**6. Control Tower** - Airports, especially in big cities, can become very busy. When airplanes are landing, taking off and taxiing, someone needs to direct them to prevent collisions with each other. The control tower does this. People in the control tower talk to the pilots in the airplanes through a radio. They direct the traffic, both airborne and on the ground, to keep the pilots and passengers safe.

**7. Runway Numbers** - The runway numbers indicate the direction that the runway points in tens of degrees oriented to a magnetic compass. If a runway faces 120 degrees by a magnetic compass, it is referred to as "Runway 12". Because a runway has two ends, each end has a different number. The opposite end of the runway is always 180 degrees different. In our example, the opposite end of "Runway 12" (120 degrees) is "Runway 30" (300 degrees). The control tower tells the pilots which runway to use by use of the runway number. Example; "Flight 124, you are cleared to land on runway 30". For airports with multiple runways oriented the same direction (parallel runways), they will be designated left and right, i.e. Runway 12 Right and Runway 12 Left.

**8. Radar** - This electronic device, invented during WWII, is used to locate aircraft in the air. This information is used by the control tower personnel and other air traffic controllers to keep aircraft separated from each other to avoid mid air collisions. A

radar antenna transmits a burst of radio energy that bounces off an airplane back to the radar unit. The time it takes for the energy to make its round trip determines how far away the airplane is.

### C. Communications

**1. Radios** - Air traffic controllers and pilots rely heavily on two-way radio communications to send and receive information. Just like using a cordless telephone, pilots can communicate using plain (pardon the pun!) language. In the early days of aviation, that wasn't the case. Before wireless radios were invented, the control tower would communicate with pilots using special signals. This included the use of flares and light guns. A light gun is a hand held and aimed unit that emits red, green or white light. The user would simply aim the light gun at the receiving airplane and shine a colored light (steady or flashing). Each combination of color and duration represented an instruction for the pilot to follow. It sounds archaic, but in fact it is still used today as a back-up system in the event of radio failure. The following is a list of light gun signals and their meanings:

<u>Signal</u>	<u>Aircraft on the Ground</u>	<u>Aircraft in Flight</u>
Steady Green	Cleared for takeoff	Cleared to land
Flashing Green	Cleared to taxi	Return for landing
Steady Red	STOP	Give way to other aircraft and continue circling
Flashing Red	Taxi clear of the runway	Airport unsafe, do not land
Flashing White	Return to starting point on the airport	n/a
Alternating Red & Green	Exercise extreme caution	Exercise extreme caution

As technology advanced, radios became wireless but could not transmit voice communications long distances. Instead, a series of tones in dots and dashes (Morse Code, named after the inventor Samuel Morse) could be sent. The system was awkward to use and time consuming, but it did provide a means of communicating detailed information that wasn't possible using a light gun or flares. The Morse Code alphabet is provided for your reference.

A . _	J . _ _ _	S ...	1 . _ _ _ _
B _ _ . .	K _ . _	T _	2 . . _ _ _
C _ _ . .	L . . . .	U . . _	3 . . . _ _
D _ . .	M _ _	V . . . _	4 . . . . _
E .	N _ .	W . _ _	5 . . . . .
F . . . .	O _ _ _	X _ . . .	6 _ . . . .
G _ _ .	P . _ . .	Y _ . _ _	7 _ _ . . .
H . . . . .	Q _ _ . _	Z _ _ . .	8 _ _ . . .
I . .	R . _ .		9 _ _ . . .
			0 _ _ . . . .

Example: "SOS" (distress signal-Save Our Ship) would be ... --- ...

Radio technology developed to the point where voice communications became practical.

Today, it is the standard and virtually every student has been exposed to voice radio communications at one time or another. Ask how many students have ever played with a walkie-talkie.

Modern aircraft radios operate on the same principle.

**2. Phonetic Alphabet** - Even though the quality of voice communications improves continuously, instances arrive where words or other information needs to be spelled out for clarification. For instance, when the control tower contacts an airplane via radio, the aircraft identification number is used, i.e., "N8476JK, you are cleared to land". Because many letters sound the same over the radio, a new alphabet was developed to assure accurate transmissions. In the *phonetic* alphabet, each letter is replaced with a word starting with the letter of interest. Below is the complete phonetic alphabet:

Example: "Math" would be spelled verbally... **M**ike, **A**lpha, **T**ango, **H**otel.

A - Alpha	J - Juliet	S - Sierra
B - Bravo	K - Kilo	T - Tango
C - Charlie	L - Lima	U - Uniform
D - Delta	M- Mike	V - Victor
E - Echo	N - November	W- Whiskey
F - Foxtrot	O - Oscar	X - X Ray
G - Golf	P - Papa	Y - Yankee
H -Hotel	Q - Quebec	Z - Zulu
I - India	R - Romeo	

## Vocabulary

**Hangar:** A building to store an airplane.

**Radar:** An electronic device that locates aircraft in the air.

**Runway:** A long surface used by airplanes to takeoff and land.

**Taxiway:** A path on an airport used by airplanes to travel about the airport on the ground.

**Terminal:** A building where airplanes pick up and drop off passengers.



## Strategy

**Materials Needed:** Student activity sheets  
Transparencies of student activity sheets  
Pencils for students

**Motivation:** Poll the students to see how many have ever been to an airport. What did they remember seeing? Did they have any questions about what they saw? Most students see only the inside of the passenger terminal. Tell them they will learn about the airport outside the terminal.

A. Using Student Activity Sheet #3A, have students fill in the blank information and definitions.

B. Conduct a phonetic spelling bee using vocabulary words learned during your aviation studies or your weekly vocabulary list from your normal curriculum. Write the phonetic alphabet on the front board (or use a transparency of Student Activity Sheet #3B) and conduct the event as any other spelling bee with the exception of using the phonetic alphabet. Before you know it, the whole class will sound like true aviators!

C. Have students complete Student Activity Sheet #3C. The crossword puzzle could be done individually or in small groups. The puzzle includes material from Chapter 2 which helps provide a review of that material.

D. Optional: Using Student Activity Sheet #3B as reference, conduct a Morse Code game. Divide the class into teams of two. One student is the sender and the other, the receiver. Give each sender a written message (the same message for all) to transmit to their partner. The sender can transmit the message by writing the code on paper or send it audibly by tapping their pencil on the table or verbally calling out dashes and dots. The receiver must then decipher the message. After everyone is finished, see how many got the message correct. Now switch roles and send a new message.

**Closure:** For those students that have visited an airport, see if they saw the facilities that you discussed during this lesson. Answer any questions they may have and tell them there are many other parts of an airport that haven't been discussed but they might have seen, such as:

- Fire department
- Electronic navigation aids
- Airport lighting
- Fuel storage & fuel trucks
- Baggage handling equipment
- Airline ticket counters

## Notes

## LET'S FLY!

### Objective of the Lesson:

#### The student will be able to:

- \* **Have fun while learning!**
- \* Following directions, successfully assemble the Estes Hi-Lite®
- \* **Have fun while learning!**
- \* Correlate the parts of a real airplane to those on the Estes Hi-Lite®
- \* **Have fun while learning!**
- \* Apply their knowledge of aerodynamics by making adjustments to the model for proper flight performance
- \* **Have fun while learning!**

### Background for the Teacher

#### Hi-Lite® Assembly

Your Estes Hi-Lite® has been carefully designed to eliminate the need for glue, paint or sharp instruments, such as knives or scissors. The plastic parts of this kit are attached to what is referred to as a *tree*. To ensure no parts get lost during construction, have your students leave all the parts attached to the tree until a specific part is needed. To remove the parts, simply twist them and they will separate freely. Following the simple instructions provided with the kit, your class should be ready to fly within 30 minutes. Even little fingers will find assembly easy, especially when guided by yourself.

Your Hi-Lite® is virtually identical to a real airplane. Though powered by a rubberband instead of a gasoline engine, the thrust produced per unit weight of the model is significantly greater than a typical airplane. Just like a real airplane, your Hi-Lite® has a cambered high lift wing design, horizontal & vertical stabilizer, adjustable rudder & elevator, fuselage, landing gear and propeller. The realistic detail makes it a superb teaching aid to review the material from Lesson 2.

#### Flight Testing

Just like a real airplane, after construction, your Hi-Lite® needs to be flight tested to ensure it is assembled and balanced properly. Remember from Lesson 2, when an airplane changes attitude, it rotates about the center of gravity. The location of the lift produced by the wing and the lift produced by the horizontal stabilizer (and elevator) in relation to the center of gravity are critical for proper flight just as it is with a real airplane. The lift of the wing will try to rotate the airplane in one direction, while the lift from the horizontal stabilizer tries to rotate it the opposite direction. This concept is best demonstrated by observing children on a teeter-totter. The pivot point of the teeter-totter (fulcrum) acts as the center of gravity of an airplane. To get the teeter-totter to balance

with children of different weights, the location of the fulcrum from the forces must be adjusted.

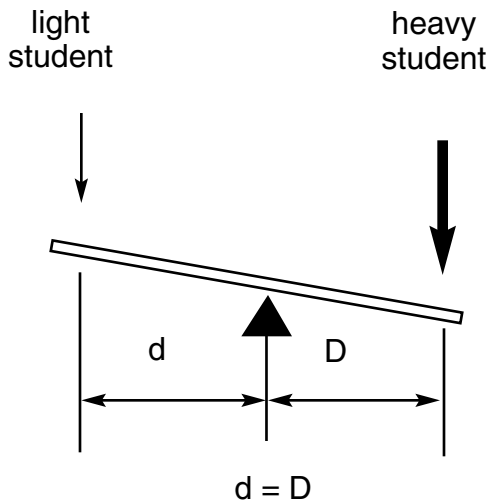

The teeter-totter is unbalanced. With both moment arms the same (distance from the force to the fulcrum,  $d = D$ ), the heavier student will cause rotation about the fulcrum.

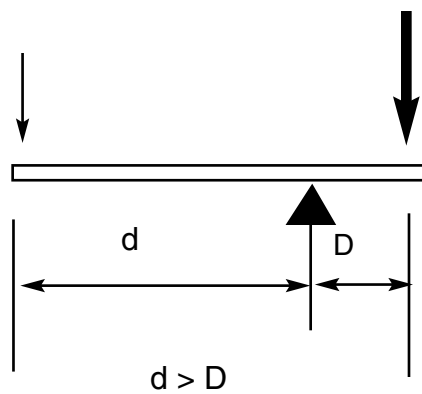

For the teeter-totter to balance, the location of the forces are adjusted (changing the moment arms)

## Center of Gravity

 = Center of Gravity

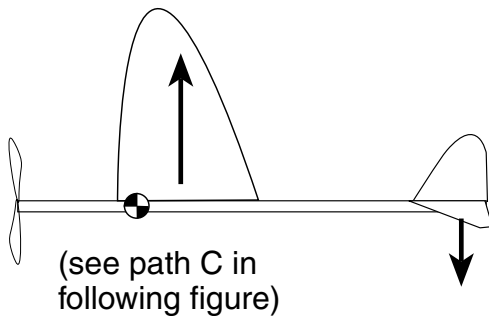

This airplane is properly balanced. The lift of the wing tries to rotate it nose down and the lift of the horizontal stabilizer tries to rotate it nose up. The moments created by the two forces are in balance and the airplane glides properly.

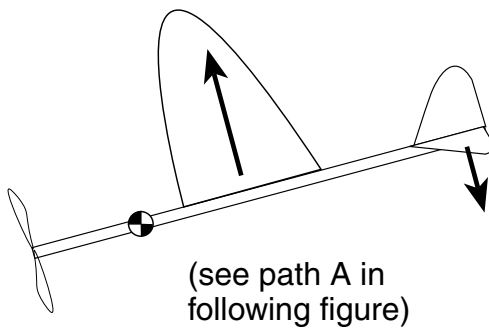

The wing on this airplane is too far back. Because the moment arm is longer, the lift of the wing causes the nose to drop more than the horizontal stabilizer lift can raise it, just like the heavier student on the teeter-totter.

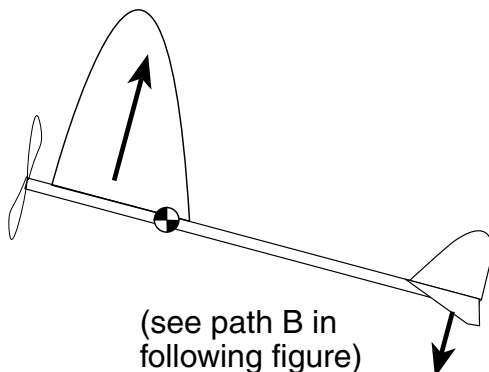

Now the wing is too far forward and causes the nose to rotate up. The tail lift also causes the nose to rotate up.

In a real airplane the pilot would control the elevator to change the tail lift, keeping the airplane balanced.

Without winding the propeller, gently hand toss the finished glider forward and observe the glide path.

If your Hi-Lite® glides like path “A” below, slide the wing forward and retest.

If your Hi-Lite® glides like path “B” below, slide the wing back and retest.

The correct flight path is “C”.

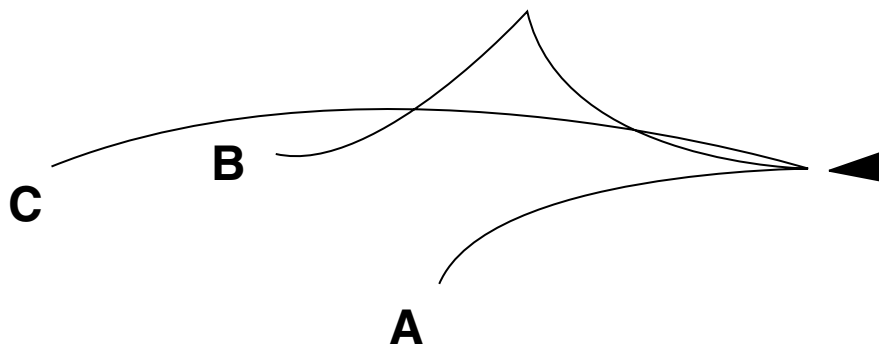
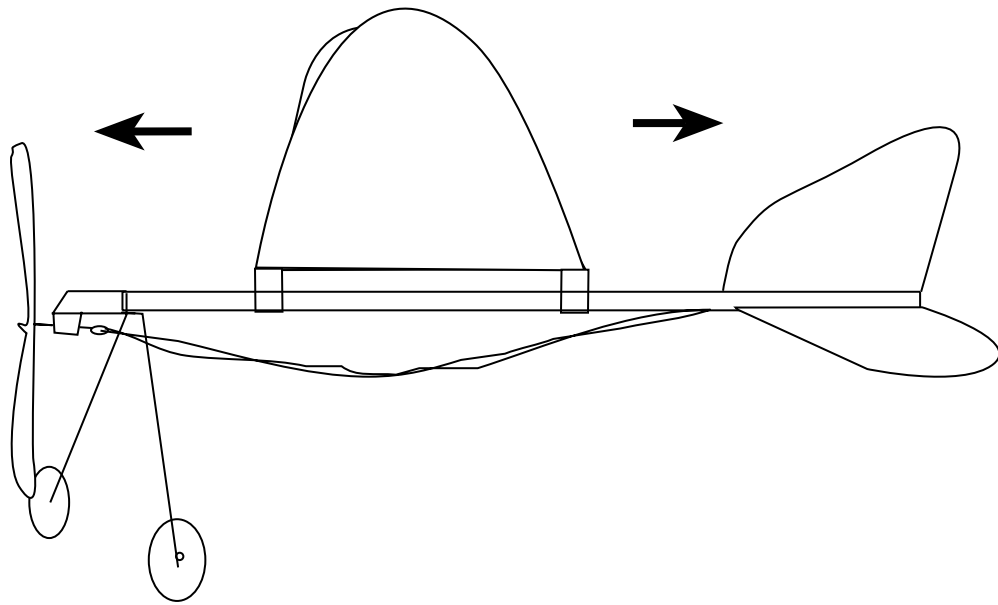

By adjusting the location of the wing, you can properly trim the airplane for flight.

## Flight Operations

**1. Turns** - This light glider has a rudder just like a real airplane and works the same way. If you want the glider to turn right and fly in a right-hand circle, deflect the rudder slightly to the right. Turns to the left require left rudder. The greater the deflection of rudder, the tighter the circle. As you remember from earlier discussions, real airplanes also use ailerons to bank the airplane in a turn. Because this is a small model, the rudder by itself is sufficient. If you were a passenger inside the Hi-Lite®, you would feel the difference and would want to use ailerons along with the rudder. Without the ailerons (rudder only), you would feel your body being pushed to the outside of the turn against the wall of the airplane's cockpit (the aviation term for this flight condition is called a *skid*). It's the same effect as making a high speed tight turn in a car, on a flat road.

**2. Climbs and Dives** - This light glider also has an elevator, just like a real airplane. To make the airplane climb, deflect the elevator up. Excessive up elevator will actually make the airplane fly in a loop. To dive, deflect the elevator down. Loop per-

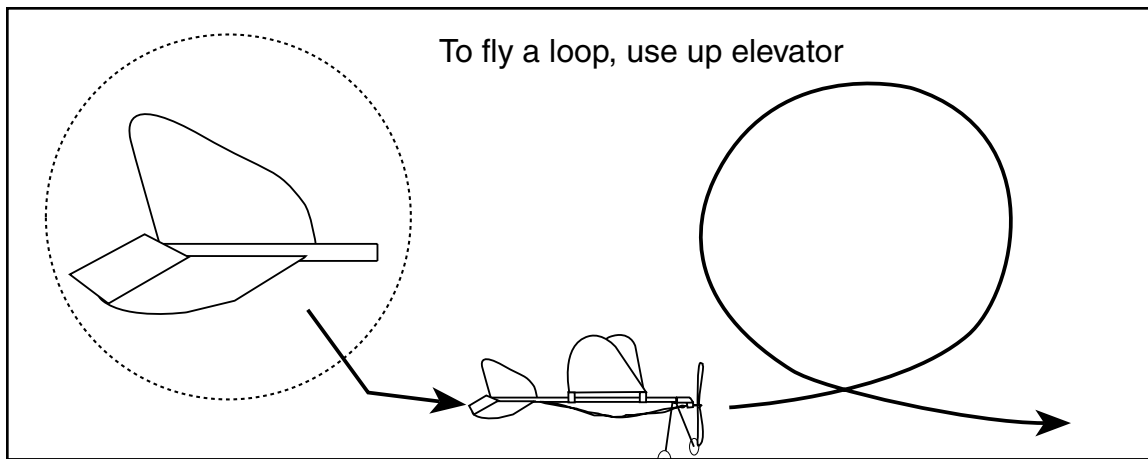

formance can also be enhanced by positioning the wing further forward.

**3. Airport Operations** - To simulate the operations of an airport, you could make an airport diagram with chalk on a blacktop surface in the playground. Now divide the class up into groups at each of the different parts of the airport and let them perform the different tasks. The control tower personnel will be in charge of the traffic flow. As the students make it to the runway, they can then fly their airplanes with your supervision. Light gliders are usually hand launched, but because the Hi-Lite® has so much power in relation to its light weight, the Hi-Lite® can actually be placed on the runway for takeoff. It will accelerate down the runway until it reaches flying speed and takeoff! Bring a magnetic compass with you and have the students determine what the runway numbers should be.

## Contests

A great deal of fun can be had with these light gliders while providing more insight into the workings of an airplane. Try these with your students:

**1. Duration** - Using a stopwatch, time their flights and see whose can stay aloft the longest. You'll be surprised with the duration times. See how many flew longer than the Wright Brothers' first flight.

**2. Farthest Distance** - Adjust the rudder so the airplane flies straight. Have each student launch from the same location and see how far they go. You can measure each distance or have each student stand at the location where the airplane landed. At the end, you can eyeball which glider went the farthest. Distances are in relation to the takeoff point, so each airplane can fly a different path, in a different direction.

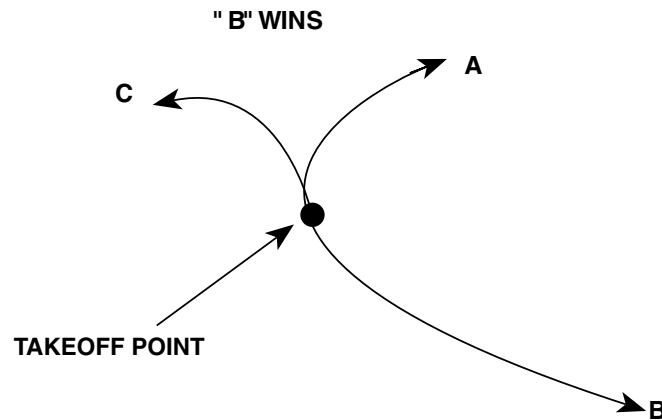

**3. Obstacle Clearance** - Some smaller airports may have trees at the end of the runway which the pilot must fly over during takeoff. You can simulate this by placing a volleyball net in the path and have the students try to fly over it. You don't want to use a hard obstacle or the glider may be damaged on impact.

**4. Race Track** - In this contest, the student is to fly as many complete circles as possible before the glider lands. Good rudder control is required to fly fast, tight turns.

**5. Ground Takeoff** - All the previous events can also be performed with a takeoff from the ground. Use the runway sketch drawn with chalk.

### Strategy

**Materials Needed:** Estes Hi-Lite® glider  
Ruler  
Pencil  
Stopwatch  
Tape measure (optional)



**Motivation:** Ask your students how far and how long the Wright Brothers' first flight went. The airplane flew 120 feet and lasted only 12 seconds. That distance is less than the wingspan of a Boeing 747 passenger jet. The Estes Hi-Lite® glider is capable of performing better than the Wright Brothers' first flight. Have your students imagine the year 1900 and they are developing the first airplane. With the knowledge they now have about aviation, they could change history if able to travel back in time. The Wright Brothers' plane would have been the second successful airplane. Your class' would have been the first!

A. Have each student remove the contents of the Hi-Lite®. Using the step-by-step instructions, assemble the kit. Emphasize to the students, they are not to remove the plastic parts from the tree until that step of the construction is being conducted. **As each part is assembled, note its similarity to a real airplane.** Have the students sand any rough parts smooth, using the sandpaper provided.

**Step 1** - When attaching the wing mounts, have the students be gentle so as not to damage the wing. **The taller wing mount goes on the leading edge of the wing and the shorter mount on the trailing edge.**

**Step 2** - With a ruler and pencil, have the students lightly mark the fuselage 1 inch (25 mm) from one end. This can be eye-balled instead of measured, but it does make a good exercise for the students to practice measurements. **Slide both wing ribs over the fuselage with the small end caps facing away from each other.** The front wing rib is positioned at the 1 inch (25mm) mark.

**Step 3** - The landing gear slides easily into the grooves on the inside of the propeller assembly. Slide the front end of the fuselage into the propeller assembly.

**Step 4** - Slide the tail mount onto the back end of the fuselage. **Notice that the rubber band loop is pointed down.**

**Step 5** - Insert the rudder into the tail groove first. The horizontal stabilizer then slides forward into the notch under the tail mount, then the trailing edge is placed under the rear tail mount tab. Normally the purple printed side is facing up. In some instances, you can actually increase the performance by inserting the horizontal stabilizer purple printed side down. Sometimes the purple surface imparts a camber to the horizontal stabilizer causing lift to be generated up instead of down which is the normal case. Inverting the horizontal stabilizer changes the lift direction to down, as shown in the earlier diagrams.

**Step 6** - To secure the rudder and horizontal stabilizer , push the stabilizer clamp up into position.

**Step 7** - Snap the wing onto the wing ribs. **Make sure the leading edge is facing forward.** The leading edge is **straight**, whereas the trailing edge is swept (angled).

**Step 8** - The rubber band is extremely long and needs to be doubled over for use. Slip the rubber band through the loop in the tail mount until it is divided in half.

**Step 9** - Connect both dangling ends of the rubber band to the hook on the propeller. **Do not** attempt to close the gap in the propeller hook after inserting the rubber band. This could damage the propeller shaft, rendering the propeller inoperable.

**Step 10** - To position the wing as close to the proper point for trimming prior to flight testing, have the students measure the gap between the propeller assembly and the front wing rib and adjust as necessary to ensure a 3/4 inch (19 mm) gap. This generally trims the airplane very close to the proper glide.

B. Using Student Activity Sheet #4A, show how the location of the wing (lift) affects the attitude of the airplane. To physically demonstrate this, have the students place their worksheet on the desk with one finger positioned on the center of gravity of the first figure. With another finger, position it on the lift force and push the paper in the direction of the lift. The paper will try to rotate. Then show how the horizontal stabilizer lift tries to balance it by causing rotation in the opposite direction. Place a finger on the horizontal stabilizer lift and push in the direction shown. The airplane tries to rotate the opposite direction. Using the two remaining figures, explain how the incorrect position of the wing will cause the airplane to climb or dive excessively.

C. Take the students outside to an open area for flight testing. Have them gently hand launch their airplanes (without winding the rubberband) and make wing adjustments until the airplane produces a smooth glide. If their airplanes make steep dives continually after trimming the maximum possible, the performance could be increased by inverting the horizontal stabilizer.

#### **D. GO FLY!!**

At this point you have many options. You could have the students sketch an airport on a blacktop surface, complete with taxiways and runways. Then conduct the contests as previously discussed. The contests can be initiated from runway takeoffs or hand launched. The Hi-Lite® propeller can be wound up approximately 150 times. It would be a good idea to procure additional rubber bands (available at most hobby shops) in the event a student attempts a world record for rubber band windings. With their academics complete, it's time to have fun. The students will quickly learn how to adjust the control surfaces to achieve the flight parameters they desire.

**Closure:** Many of your students have probably flown small balsa or paper gliders before, but few if any understood how and why they flew. Ask them and compare that with their knowledge now. Has this unit generated interest that wasn't there before? It's possible, your class now has many future aerospace engineers.

## **Notes**

**Student**

**Activity**

**Sheets**

# Student Activity Sheet #1A



Courtesy of Civil Air Patrol

## Icarus & Daedalus

Year \_\_\_\_\_

Notes \_\_\_\_\_

---

---

---

---



Courtesy of Civil Air Patrol

## Chinese Kites

Year \_\_\_\_\_

Notes \_\_\_\_\_

---

---

---

---

# Student Activity Sheet #1A (continued)

## Cork in Water

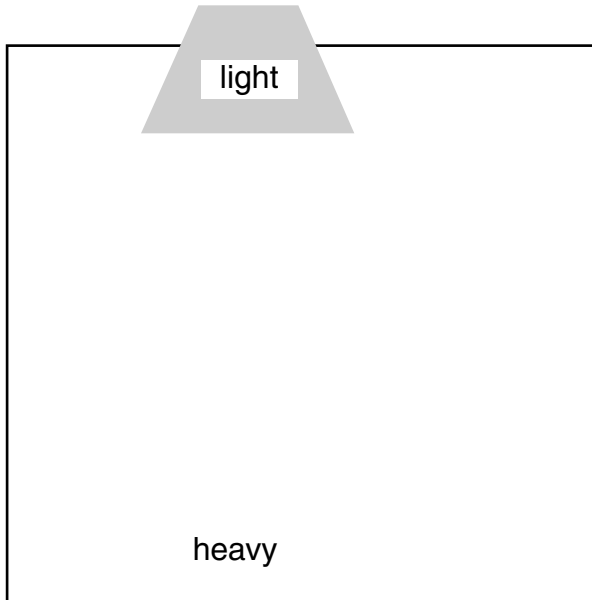

Archimedes

Year \_\_\_\_\_

Notes \_\_\_\_\_

---

---

---

---

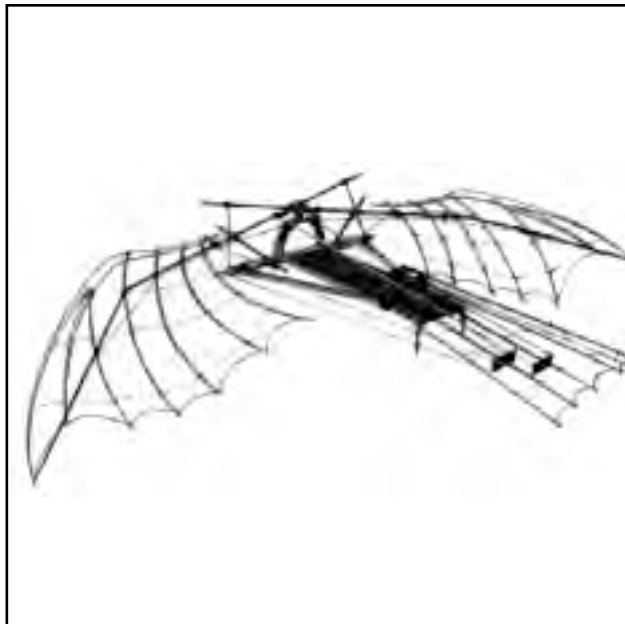

Ornithopter

Year \_\_\_\_\_

Notes \_\_\_\_\_

---

---

---

---

Courtesy of Civil Air Patrol

# Student Activity Sheet #1B

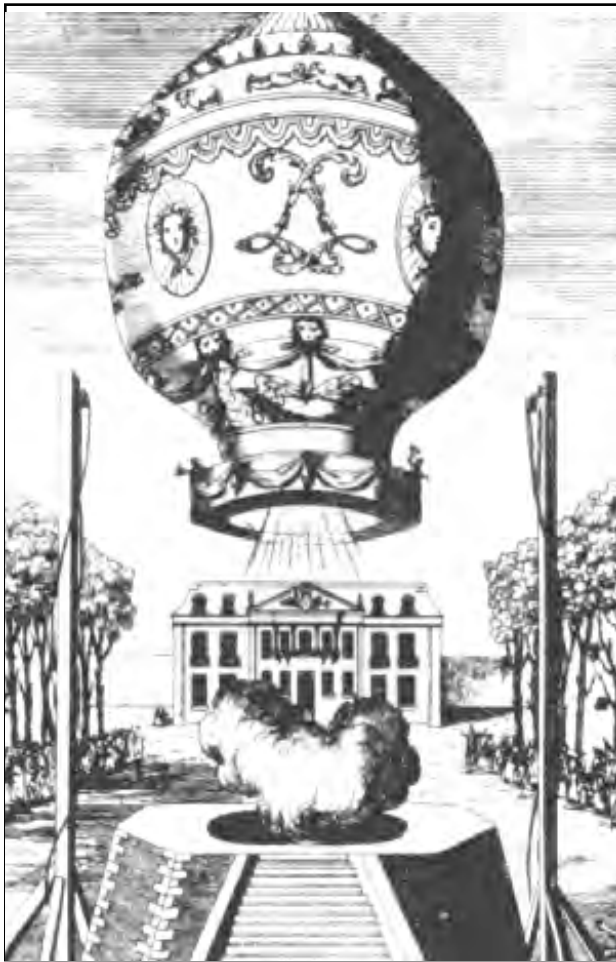

Courtesy of Civil Air Patrol

## Montgolfier Brothers

Year \_\_\_\_\_

Notes \_\_\_\_\_  
\_\_\_\_\_  
\_\_\_\_\_  
\_\_\_\_\_  
\_\_\_\_\_



Courtesy of Civil Air Patrol

## Civil War Balloon

Year \_\_\_\_\_

Notes \_\_\_\_\_  
\_\_\_\_\_  
\_\_\_\_\_  
\_\_\_\_\_  
\_\_\_\_\_

**Student Activity Sheet #1B (continued)**

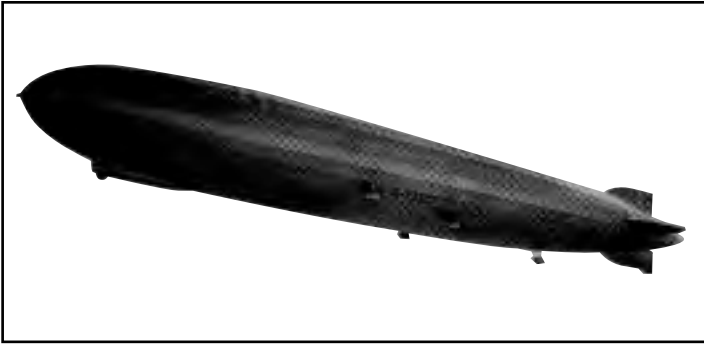

Courtesy of Civil Air Patrol

**Zeppelin**

Year \_\_\_\_\_

Notes \_\_\_\_\_

---

---

---

---

---



Courtesy of NASA

**U.S. Military Balloon**

Notes

---

---

---

---

---

---

---



Courtesy of NASA

**Sport Balloons**

Notes

---

---

---

---

---

---

---



# Student Activity Sheet #1C

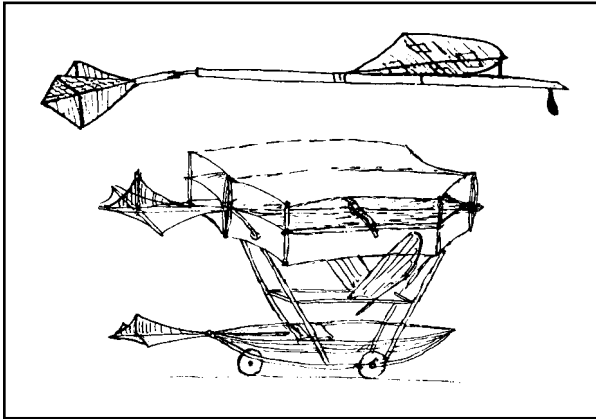

Courtesy of NASA

Sir George Cayley

Year \_\_\_\_\_

Notes \_\_\_\_\_

---

---

---

---

---

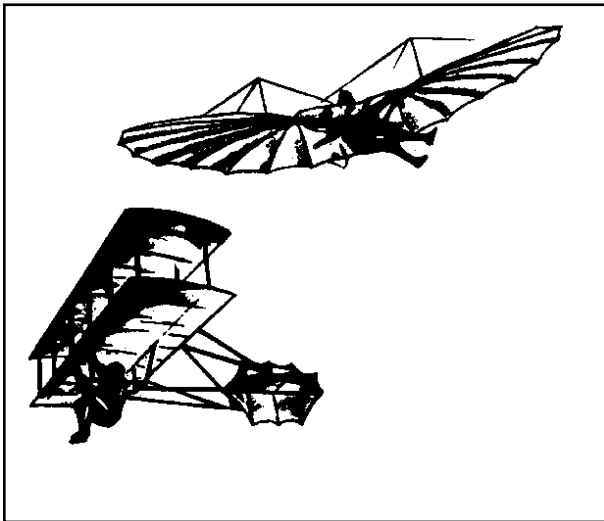

Courtesy of NASA

Otto Lilienthal

Year \_\_\_\_\_

Notes \_\_\_\_\_

---

---

---

---

---



Courtesy of NASA

Octave Chanute

Year \_\_\_\_\_

Notes \_\_\_\_\_

---

---

---

---

---

# Student Activity Sheet #1D

Aerodrome

Year \_\_\_\_\_

Notes \_\_\_\_\_

---

---

---

---

---

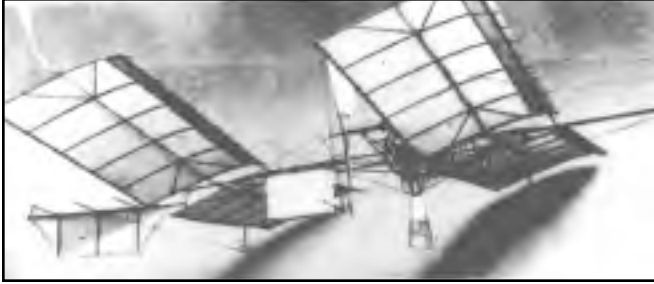

Courtesy of NASA

Wright Brothers

Date \_\_\_\_\_

Notes \_\_\_\_\_

---

---

---

---

---



Courtesy of NASA

# Student Activity Sheet #1E

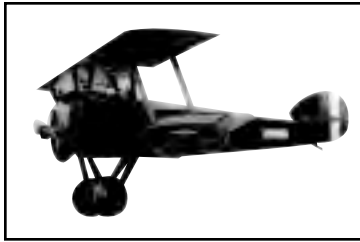

1917 WWI Fighter

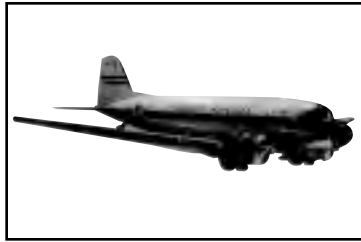

1936 DC-3 Transport

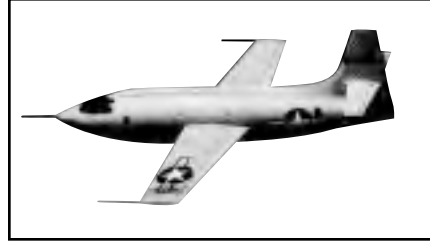

1947 Bell X-1  
First Supersonic Flight

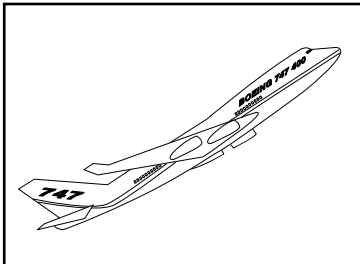

1970 Boeing 747  
Passenger Jumbo Jet

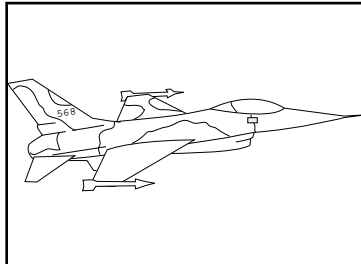

1979 F-16 Mach 2  
Jet Fighter

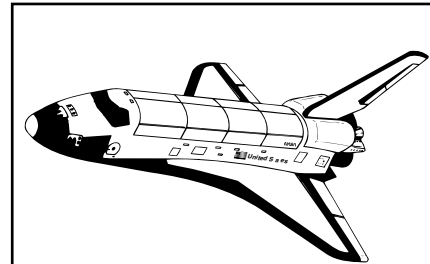

Present Day Space Shuttle

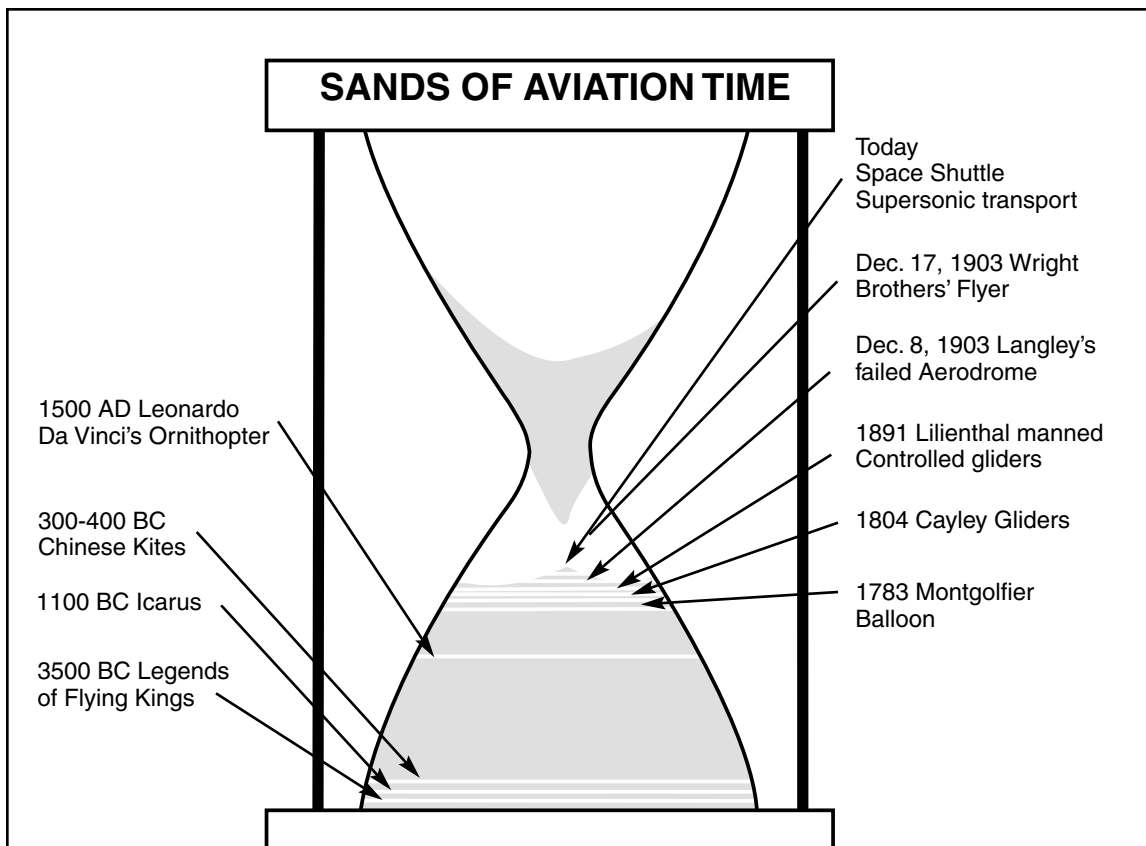

## Student Activity Sheet #2A

### Airplane Components

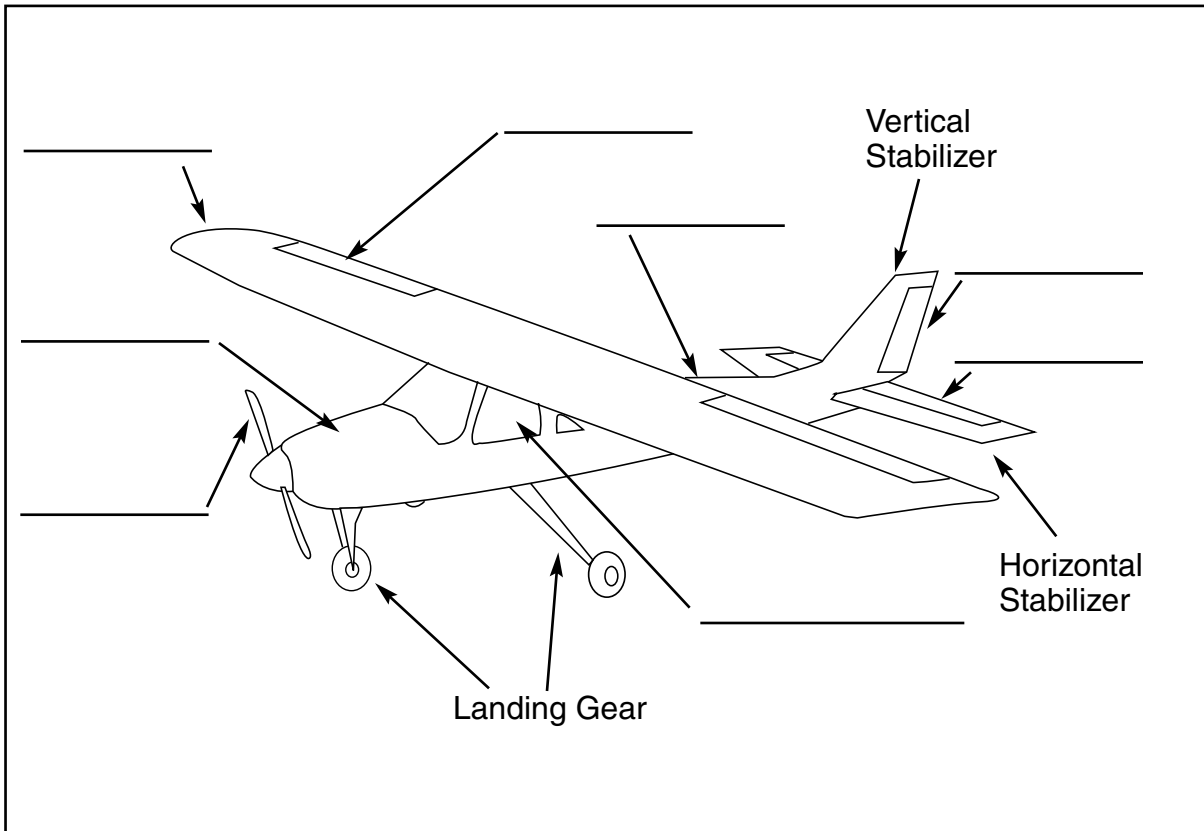

Wing

Elevator

Rudder

Aileron

Fuselage

Engine

Propeller

Cockpit

# Student Activity Sheet #2B

## Bernoulli's Principle

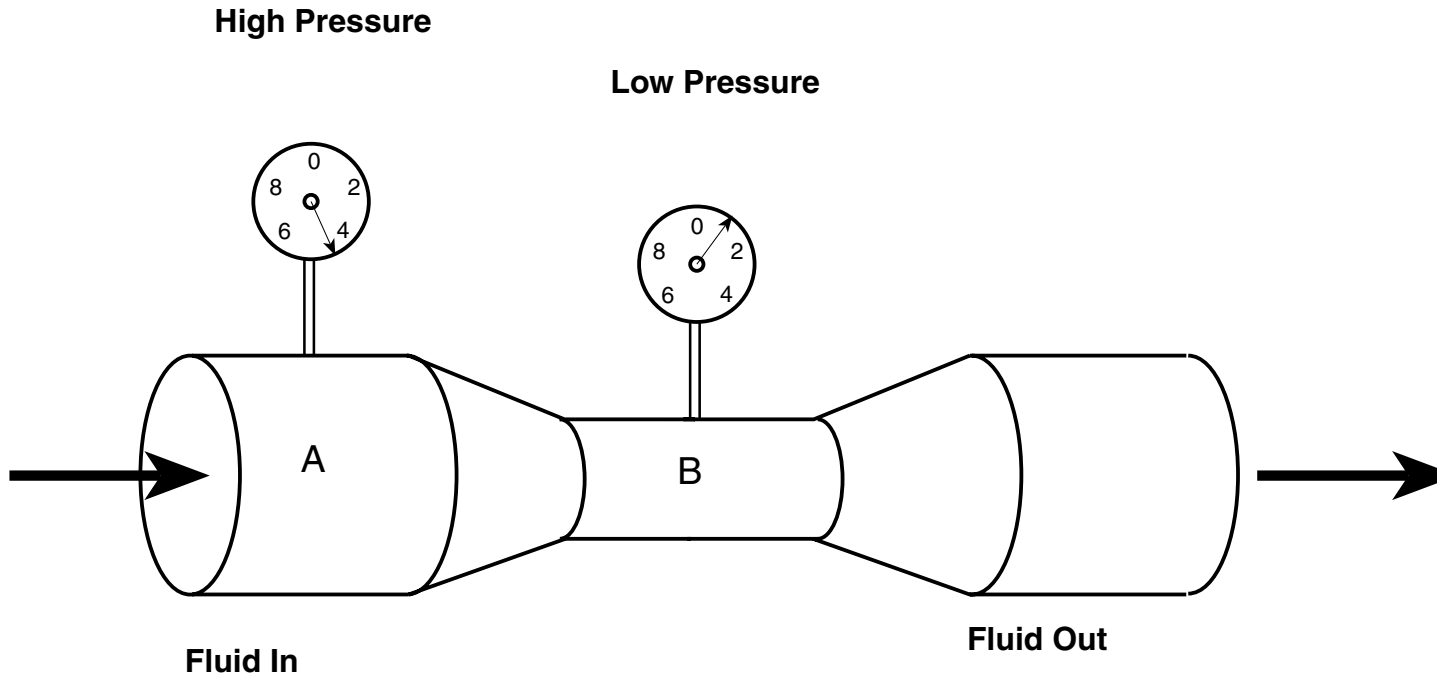

As the speed of a fluid increases, the pressure \_\_\_\_\_.

As the speed of a fluid decreases, the pressure \_\_\_\_\_.

# Student Activity Sheet #2C

## The Wing

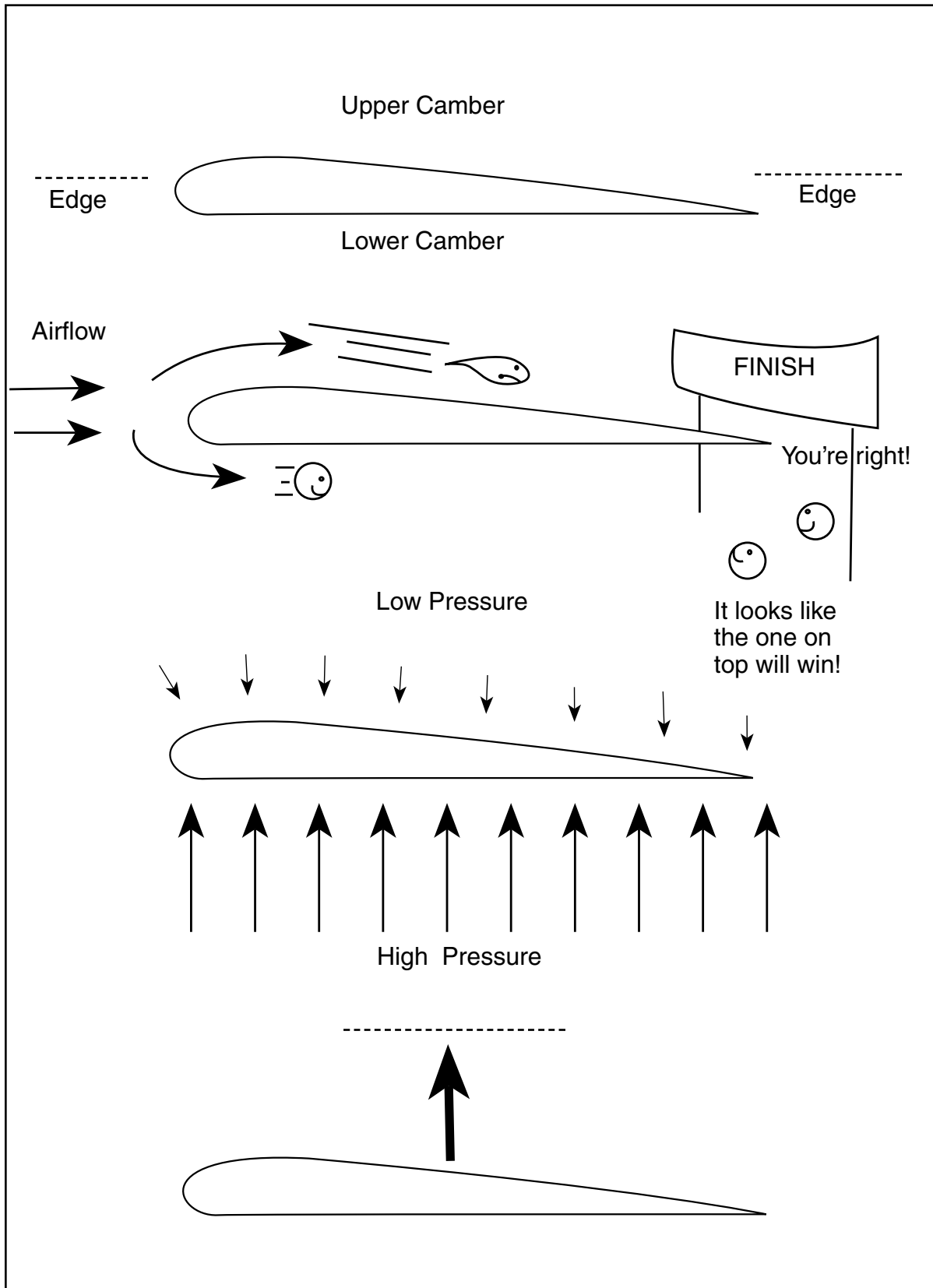

# Student Activity Sheet #2D

Connect the Dots

Student Name \_\_\_\_\_

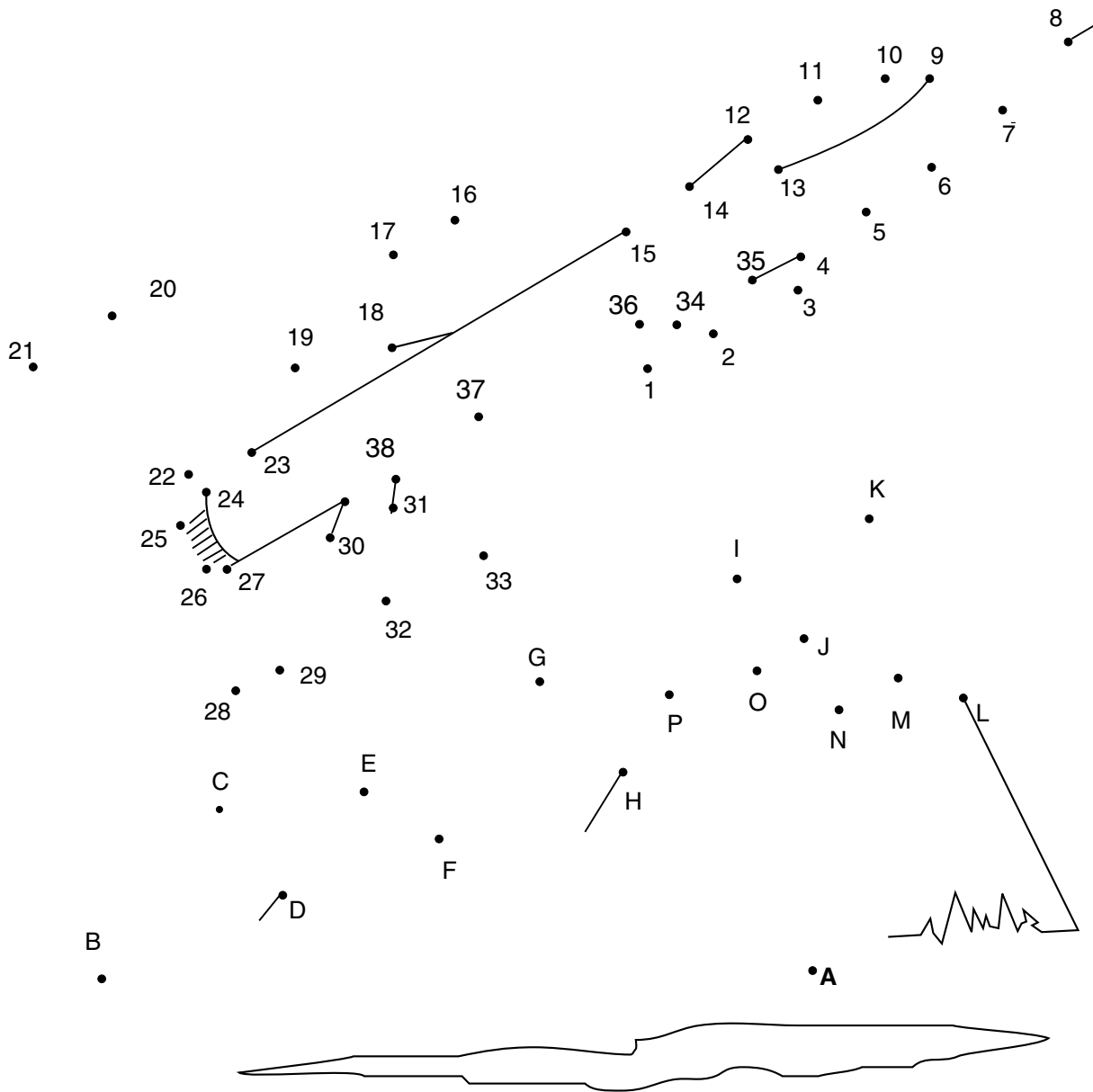

# Student Activity Sheet #2E

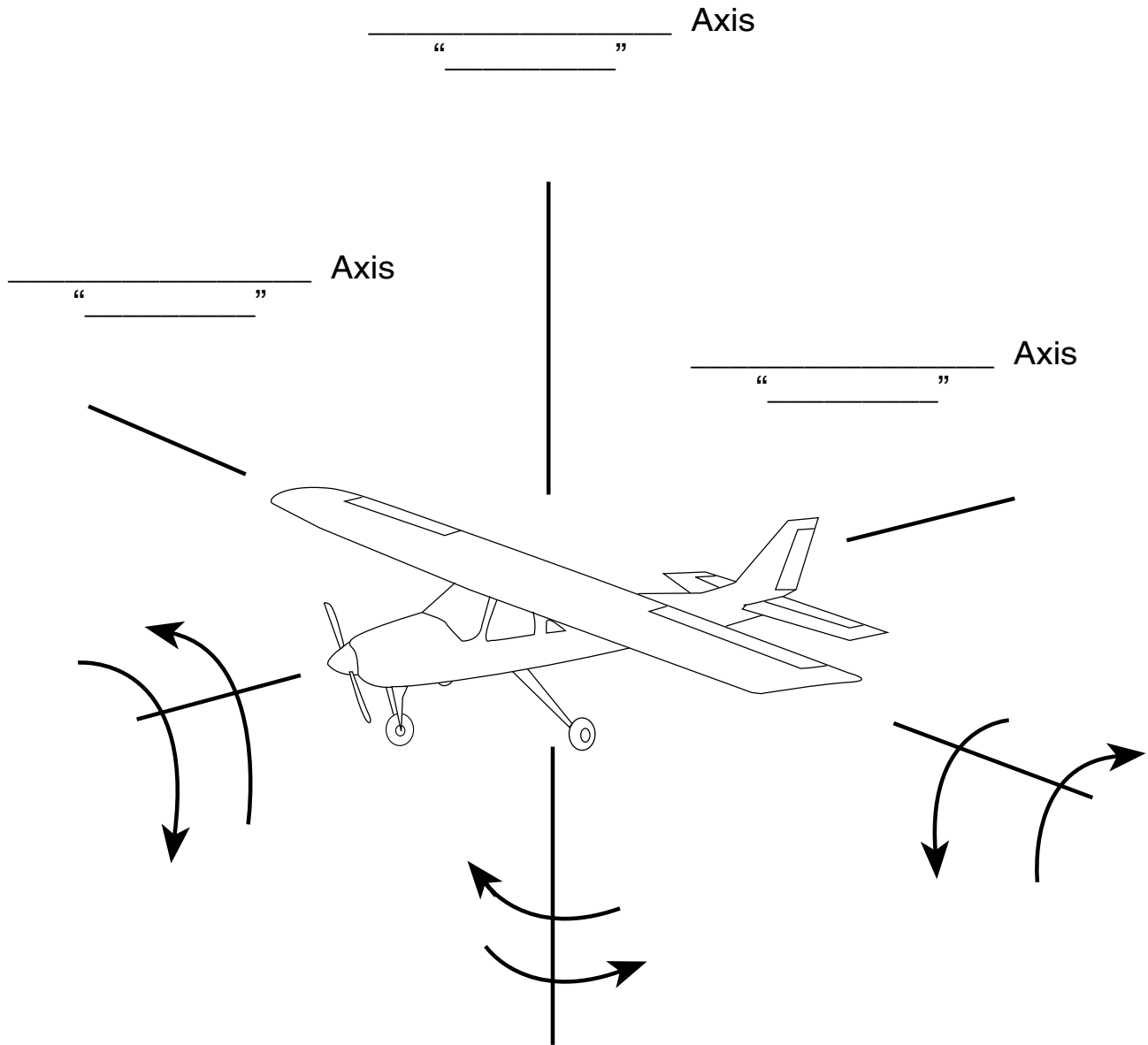



# Student Activity Sheet #2F

## Lateral Axis - Pitch

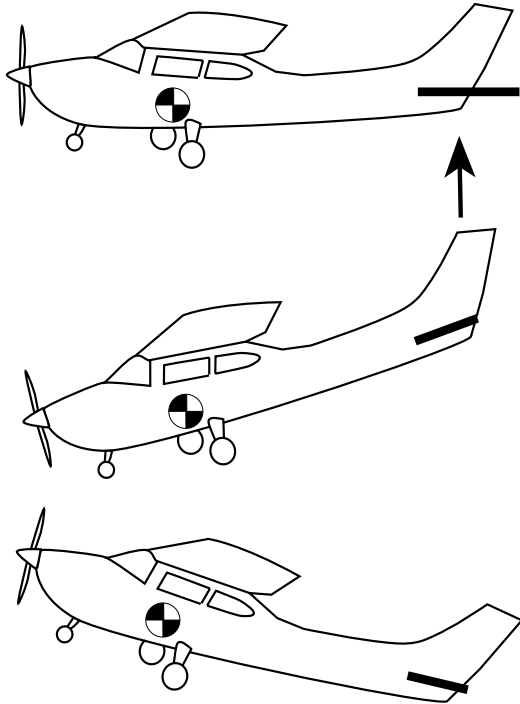

## Vertical Axis - Yaw

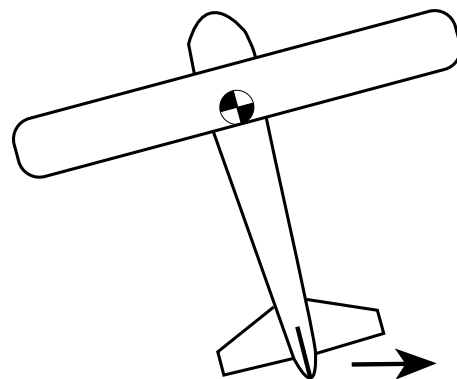
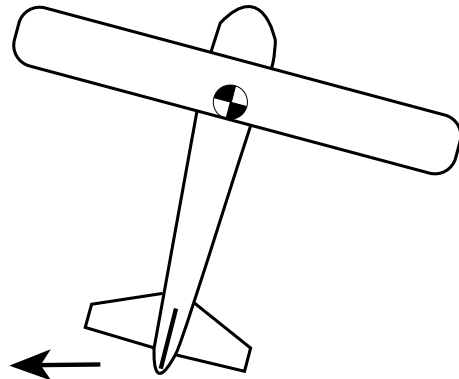
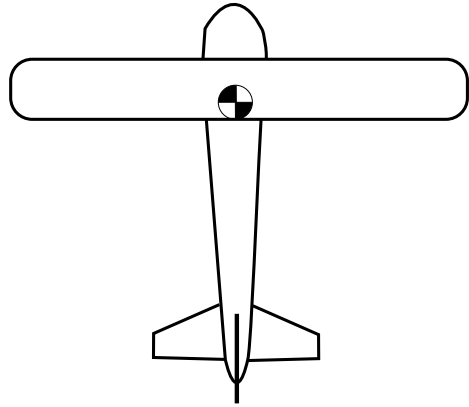

## Longitudinal Axis - Roll

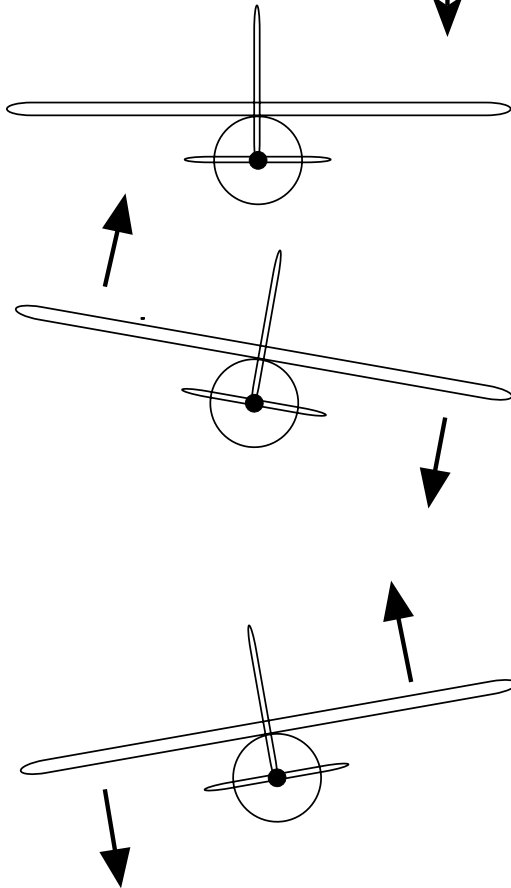

# Student Activity Sheet #2G

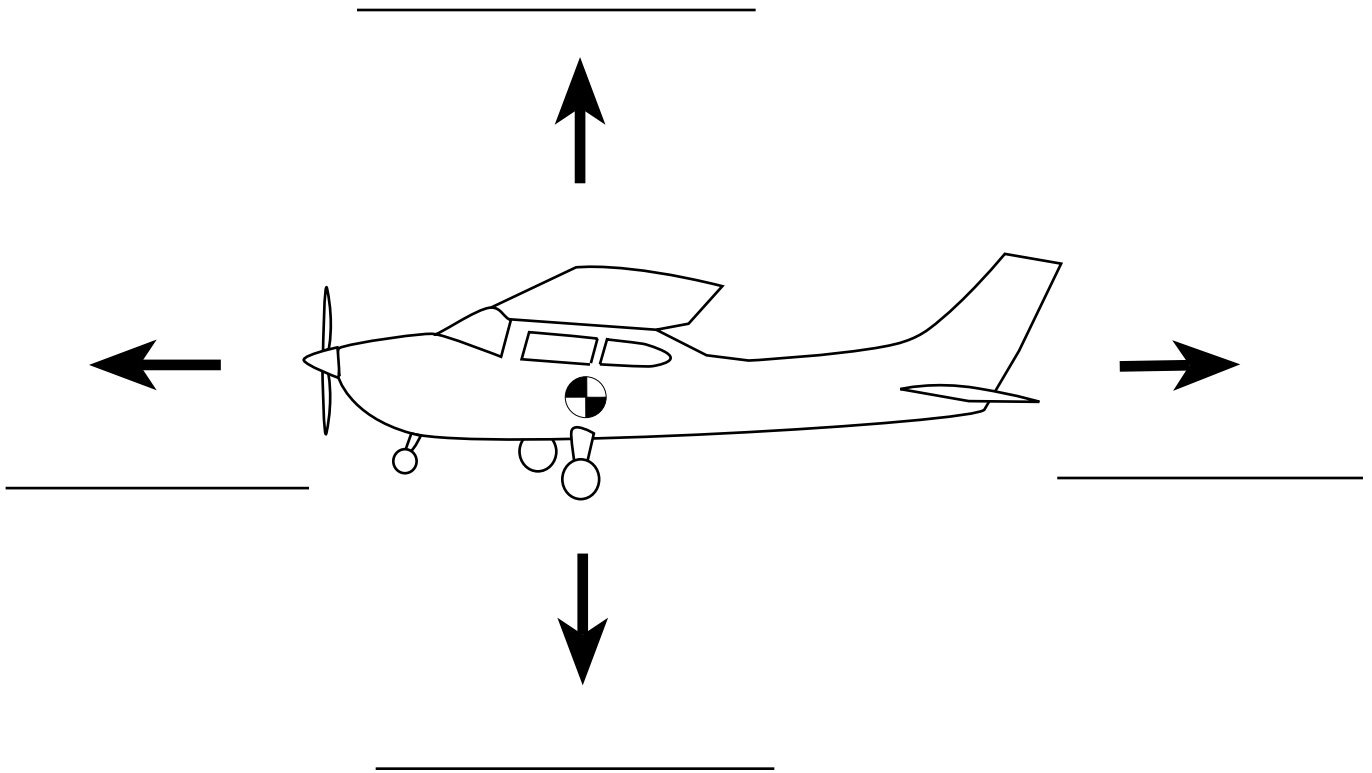

 = Center of Gravity

Climbs and Dives

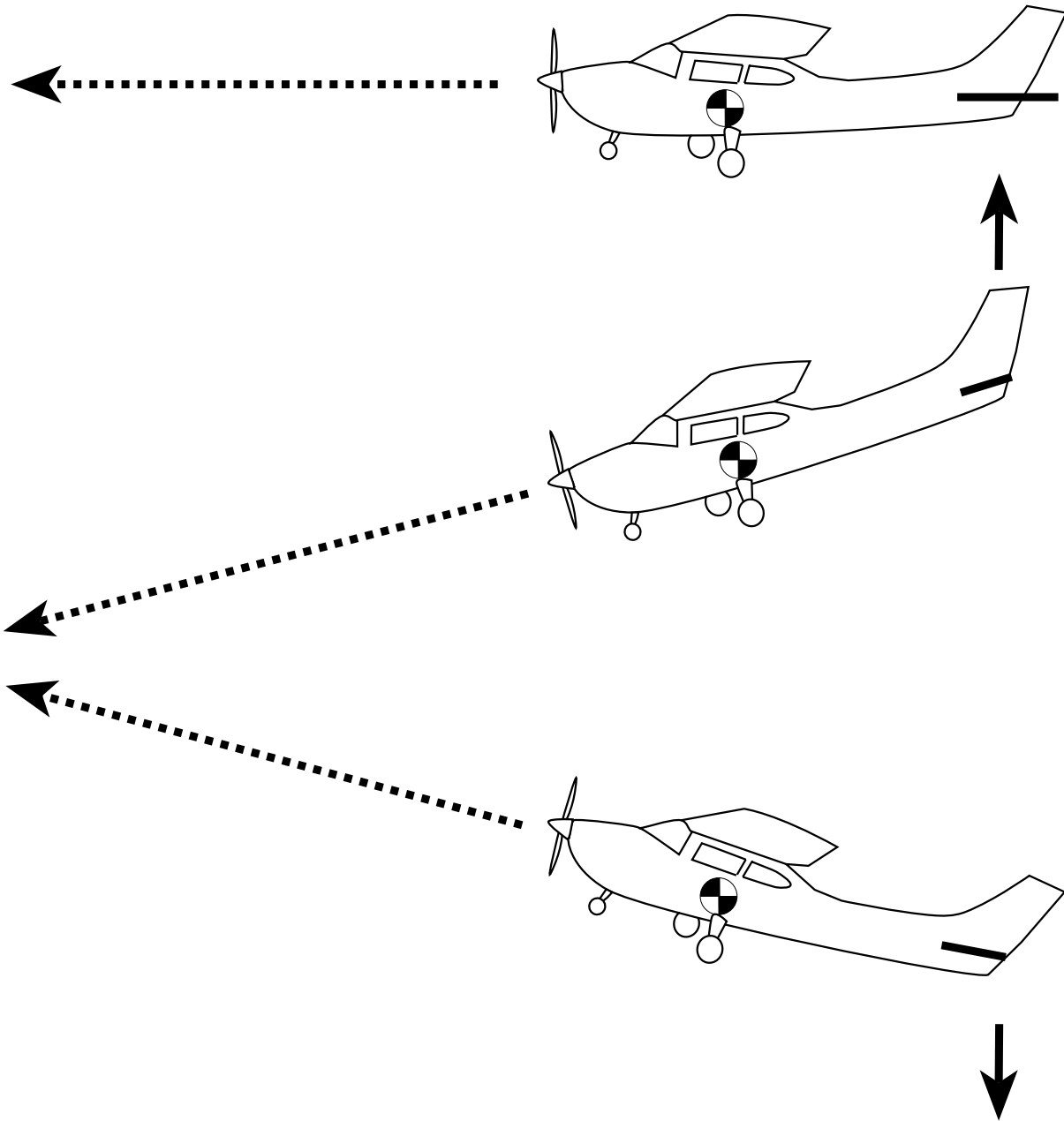

Student Activity Sheet #21

Coordinated Turn

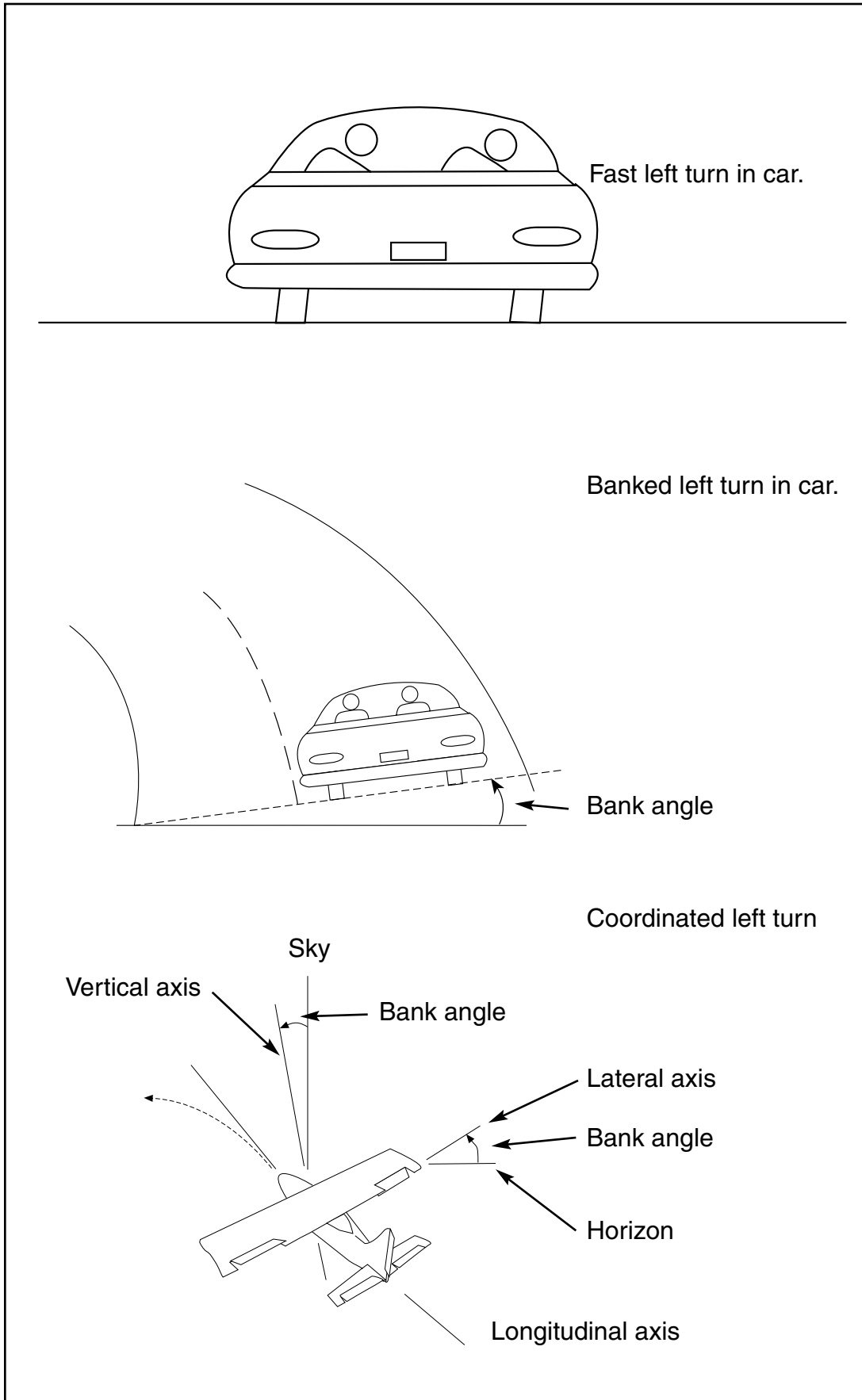

# Student Activity Sheet #2J

## The Cockpit

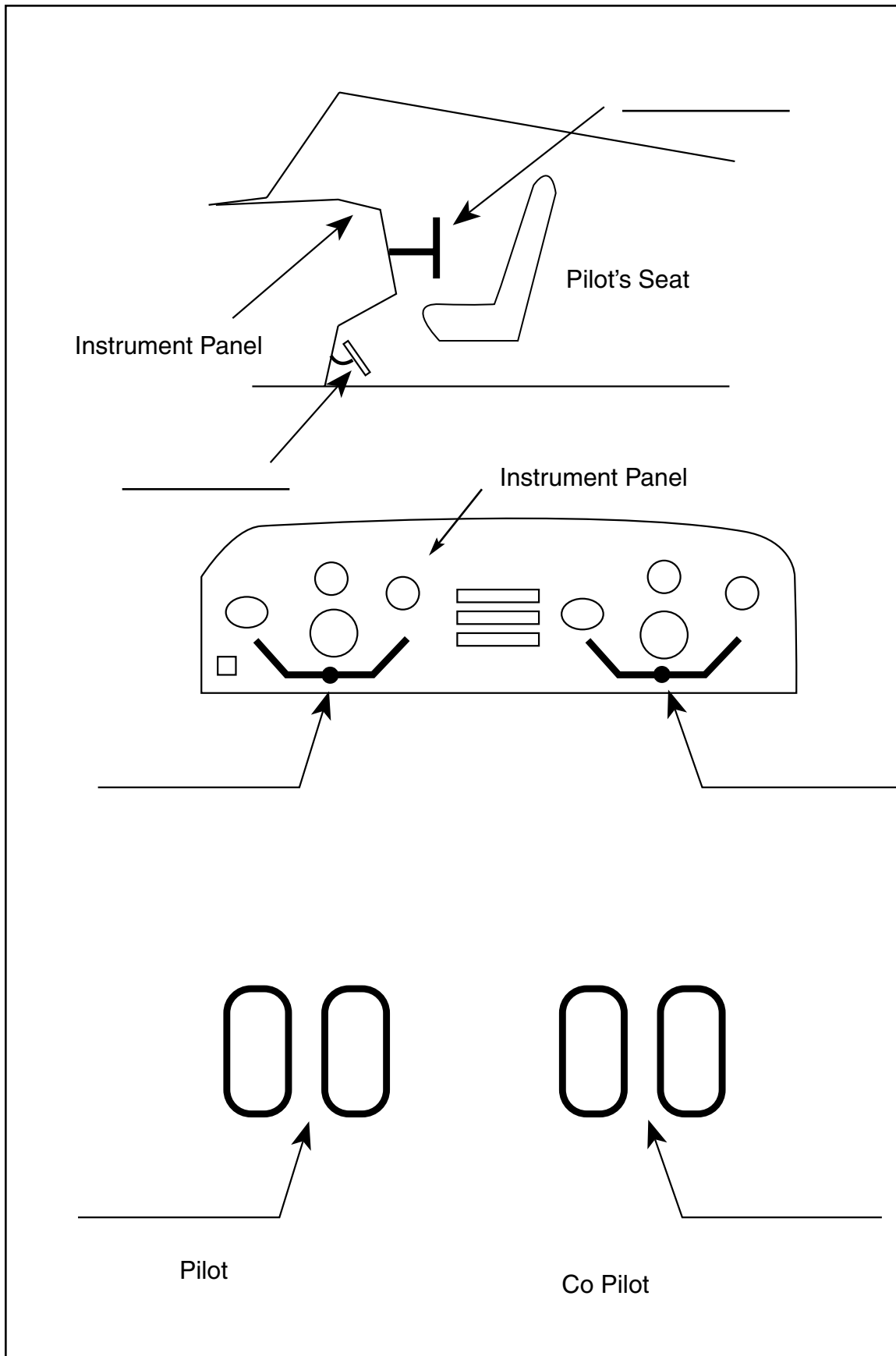

Student Activity Sheet #2K

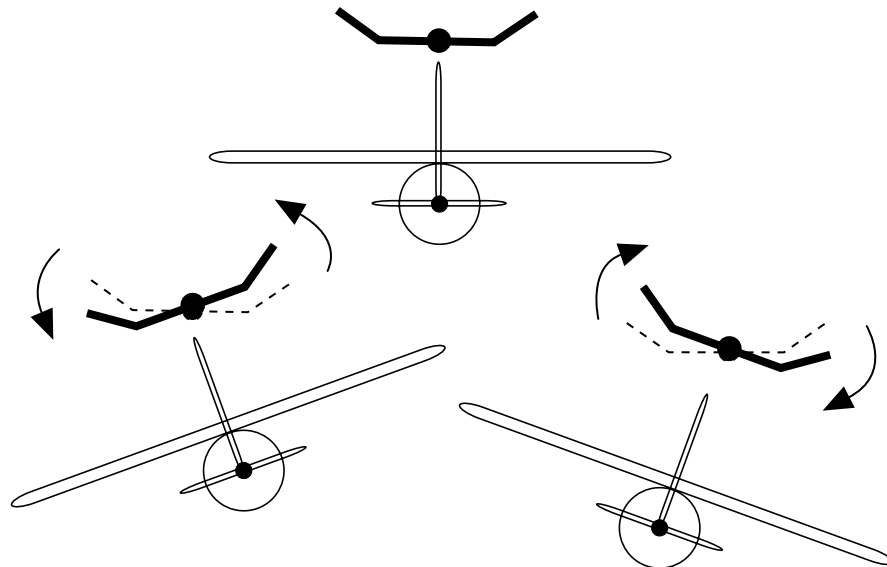
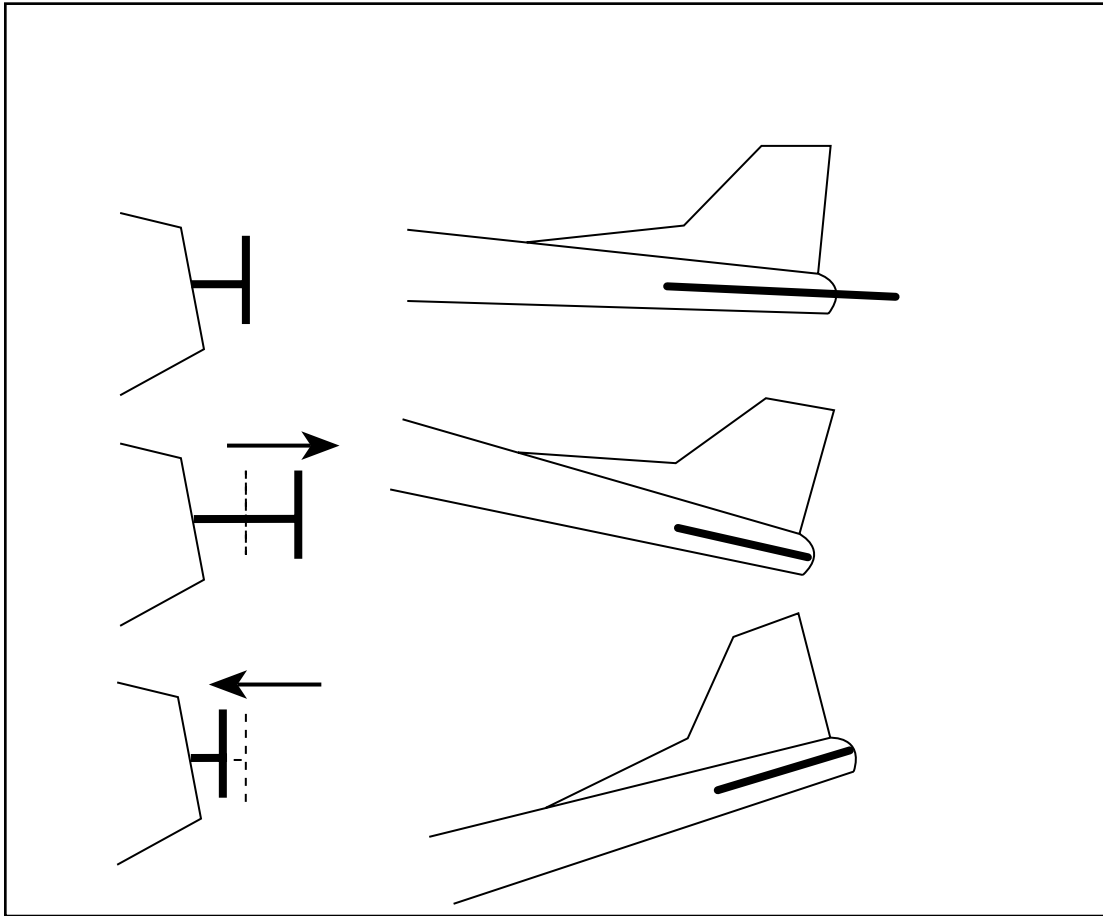

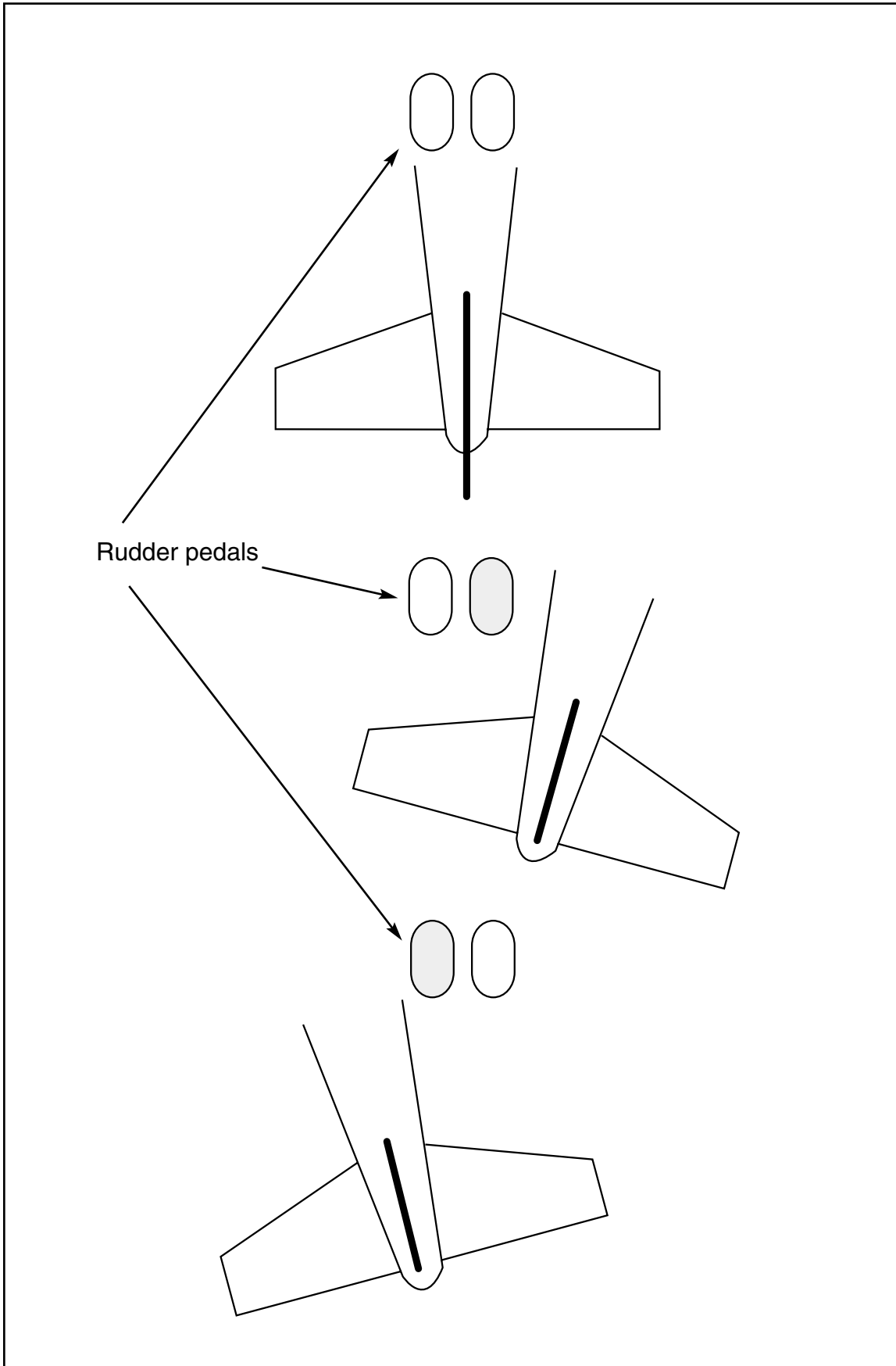

Student Activity Sheet #2K (continued)

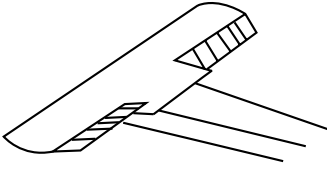
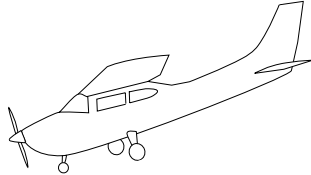

## Student Activity Sheet #2L

Matching Game - Draw a line connecting the Action with the correct Control Surface and Result.

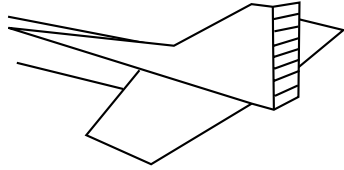
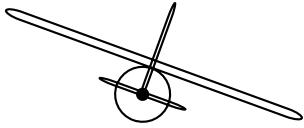
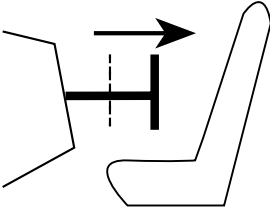
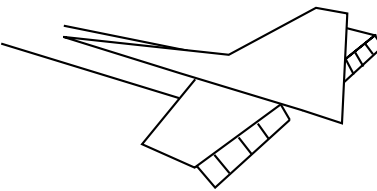
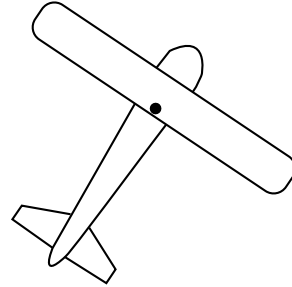
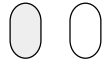
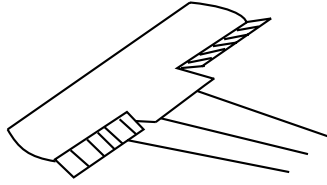
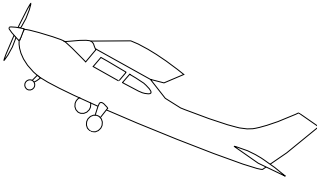
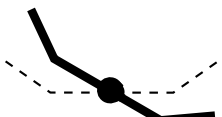
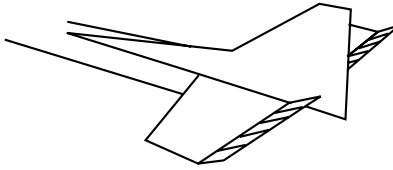
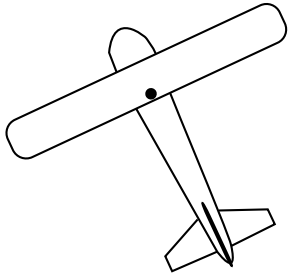
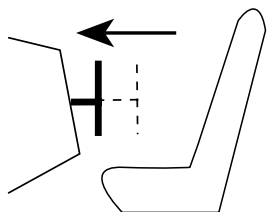
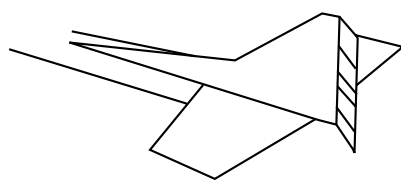
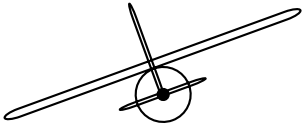
Action	Control Surface	Result
 Right Rudder		
 Control Wheel Left		
 Control Wheel Back		
 Left Rudder		
 Control Wheel Right		
 Control Wheel Forward		



# Student Activity Sheet #3A

## Airport Diagram

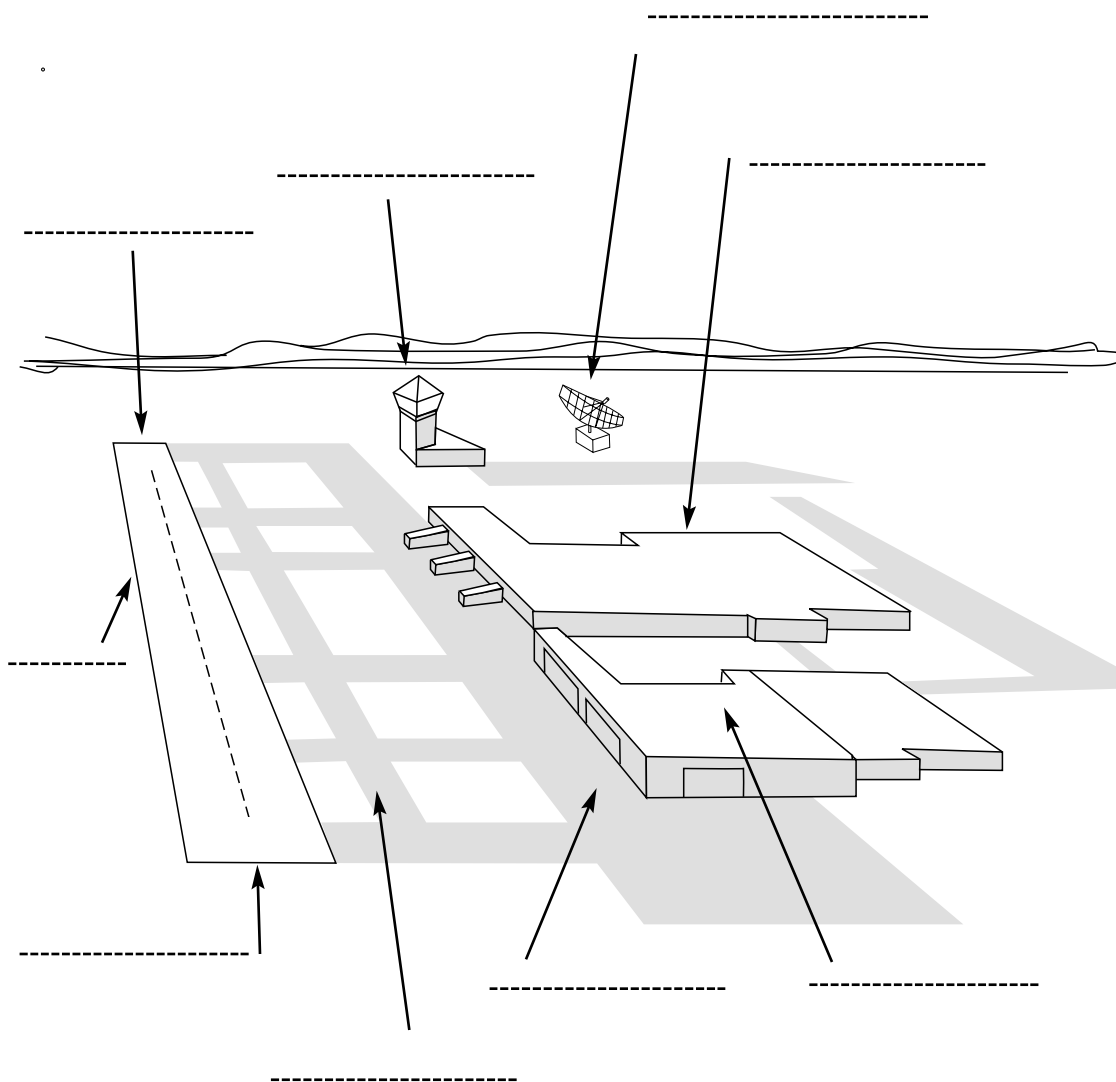

## Student Activity Sheet #3A (continued)

Runway -

Parking Ramp -

Taxiway -

Terminal -

Hangar -

Control Tower -

Runway Numbers -

Radar -

## Student Activity Sheet #3B

### Phonetic Alphabet

A - Alpha	J - Juliet	S - Sierra
B - Bravo	K - Kilo	T - Tango
C - Charlie	L - Lima	U - Uniform
D - Delta	M - Mike	V - Victor
E - Echo	N - November	W - Whiskey
F - Foxtrot	O - Oscar	X - X-Ray
G - Golf	P - Papa	Y - Yankee
H - Hotel	Q - Quebec	Z - Zulu
I - India	R - Romeo	

### Morse Code

A . _	J . _ _ _	S ...	1 . _ _ _ _
B _ _ _ .	K _ . _	T _	2 . . _ _ _
C _ _ . .	L . _ . .	U . . _	3 . . . _ _
D _ . .	M _ _	V . . . _	4 . . . . _
E .	N _ .	W . _ _	5 . . . . .
F . . _ .	O _ _ _	X _ . . .	6 _ . . . .
G _ _ .	P . _ . .	Y _ . _ _	7 _ _ . . .
H . . . . .	Q _ _ . .	Z _ _ . .	8 _ _ . . .
I . .	R . _ .		9 _ _ . . .
			0 _ _ _ _ _

### Student Activity Sheet #3C

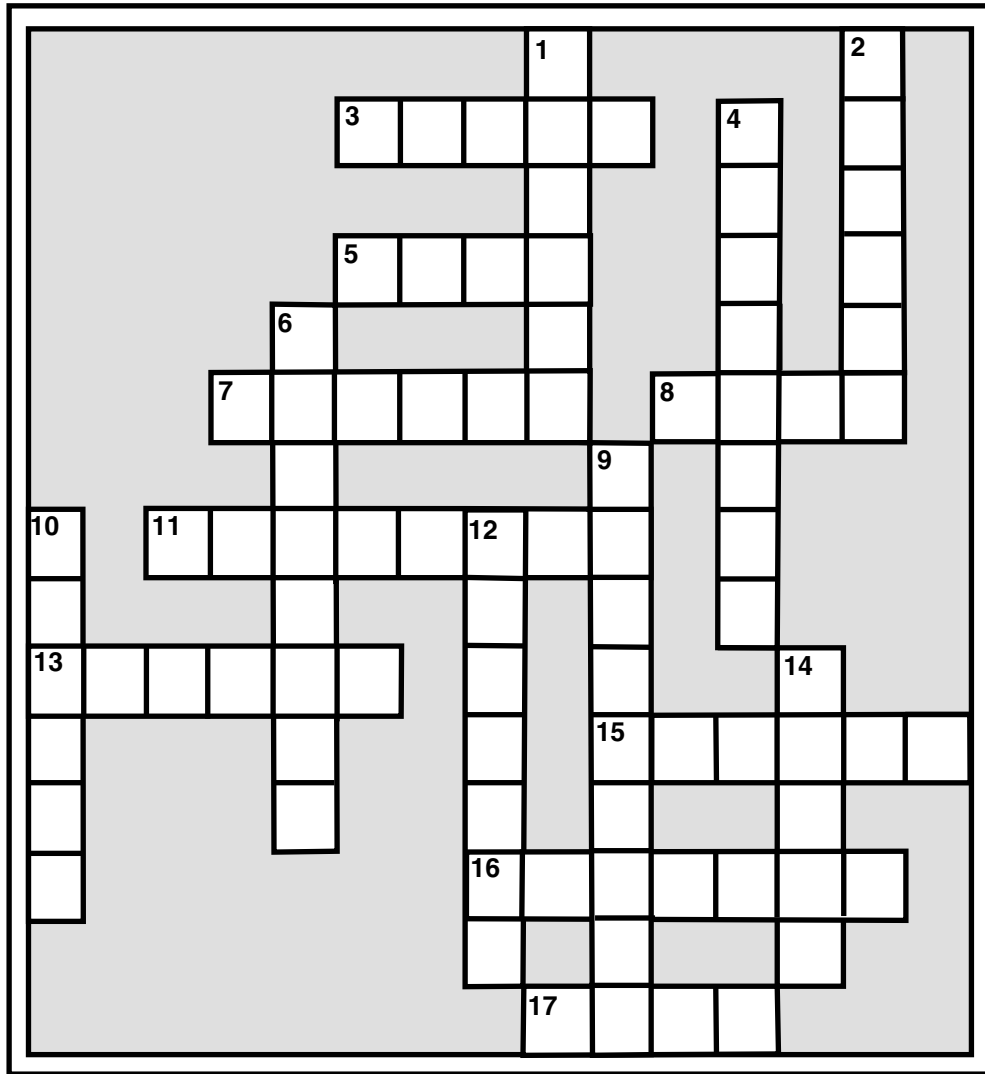

#### Across

- 3 Electronic device that locates airplanes
- 5 The airplane part that creates lift.
- 7 Connected to the vertical stabilizer.
- 8 Force generated by the wing.
- 11 Controls the airplane's pitch.
- 13 Where airplanes takeoff and land.
- 15 It powers the airplane.
- 16 Causes the airplane to roll.
- 17 Force that slows the airplane down

#### Down

- 1 Building that stores airplanes for repair.
- 2 The force working against lift
- 4 Where airlines pick up passengers.
- 6 An airplane's main body.
- 9 The spinning part that creates thrust.
- 10 The force that causes forward motion.
- 12 The path to the runway.
- 14 This person flies the airplane.

# Student Activity Sheet #4A

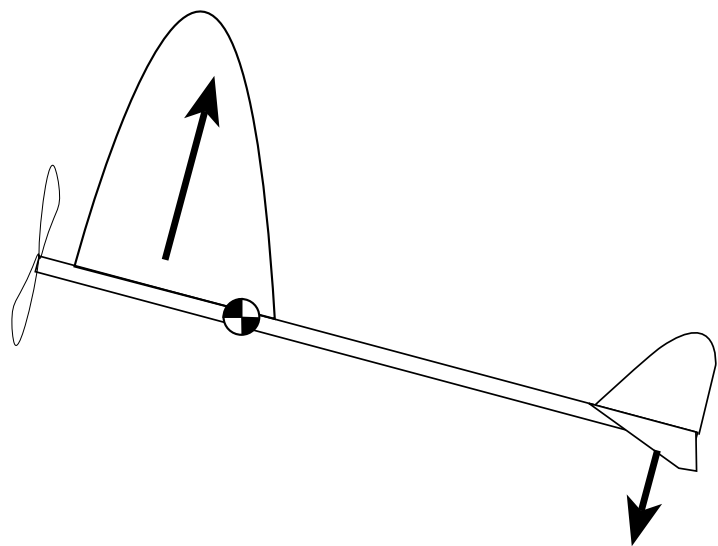
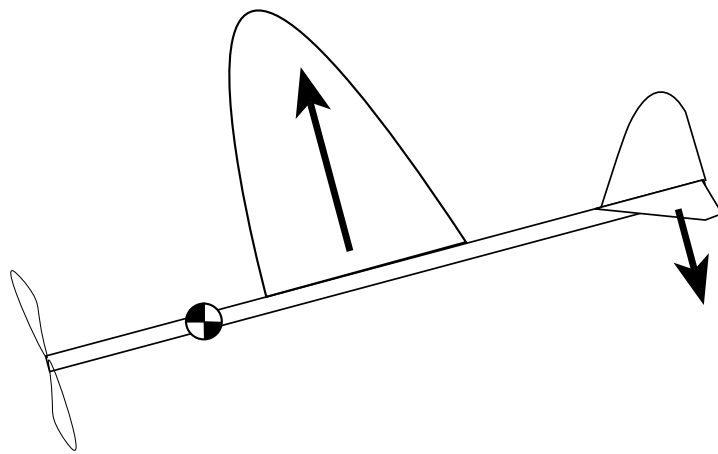
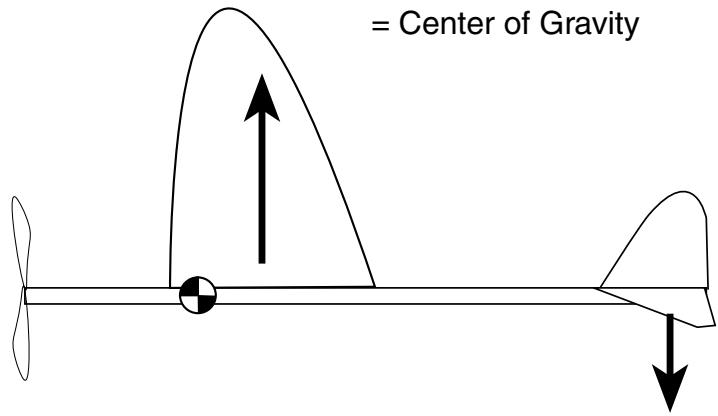



# T I M E A W A R D

A V I A T I O N C E R T I F I C A T E

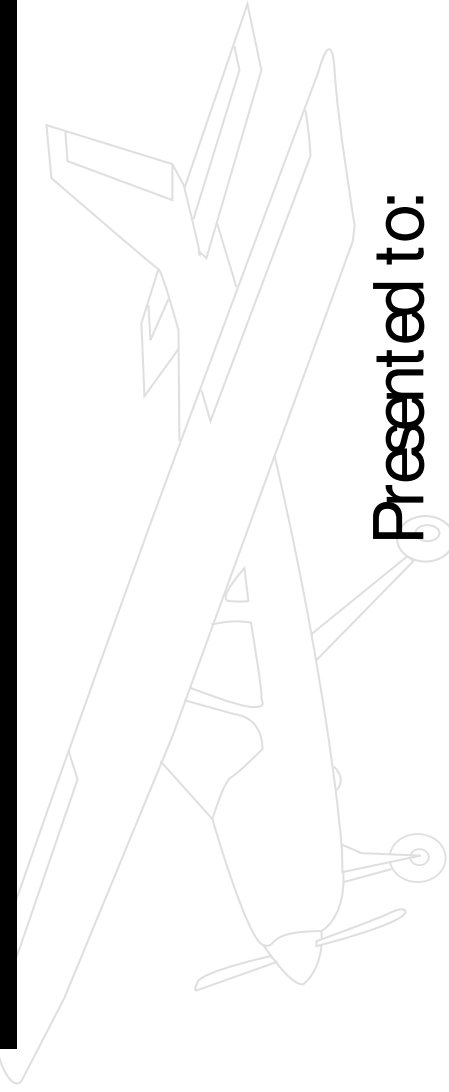

Presented to:

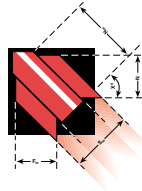

ESTES  
EDUCATOR

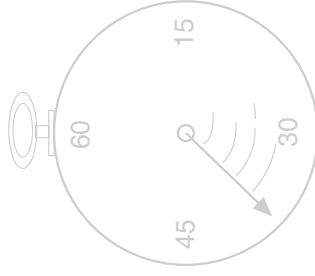

\_\_\_\_\_

Date

# T I M E A W A R D

A V I A T I O N C E R T I F I C A T E

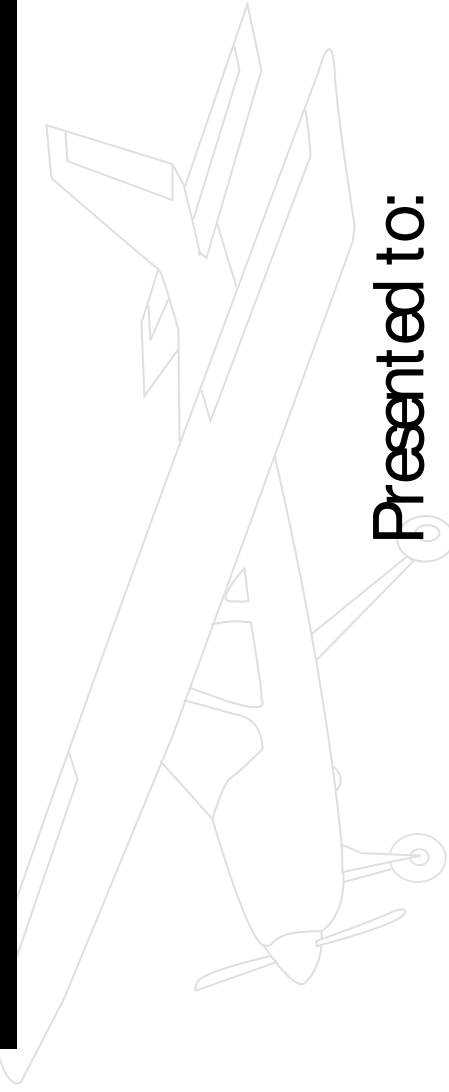

Presented to:



ESTES  
EDUCATOR

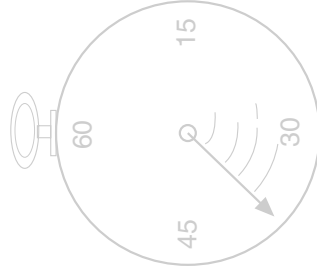

\_\_\_\_\_

Date



# DISTANCE AWARD

AVIATION CERTIFICATE

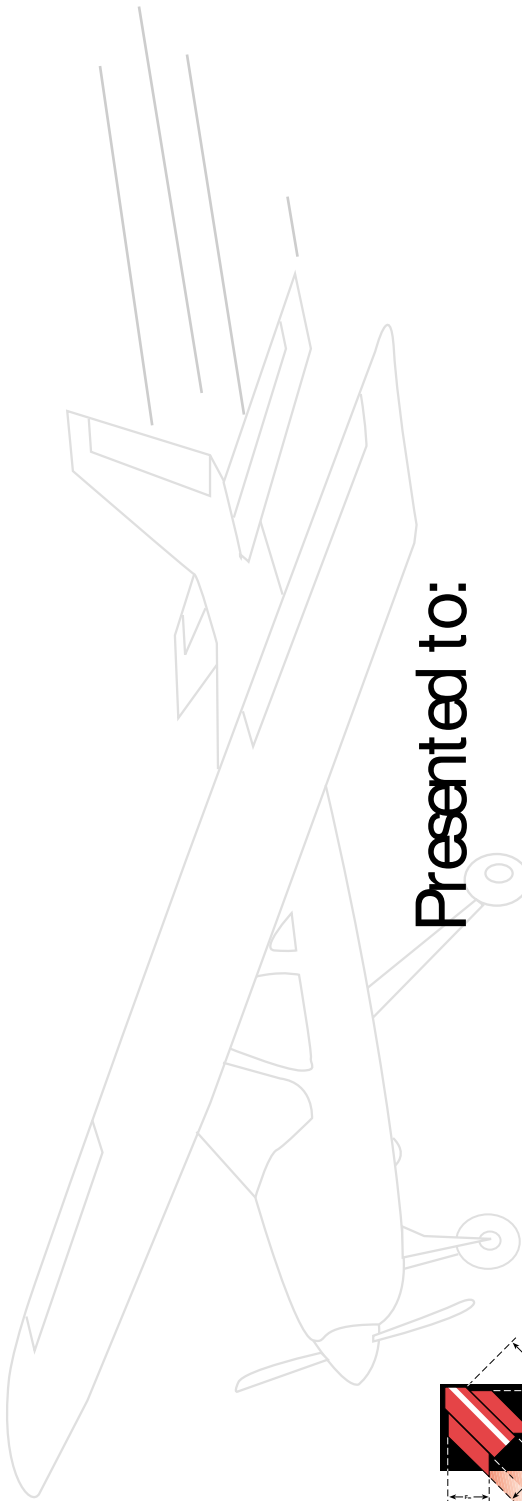

Presented to:

\_\_\_\_\_

Date

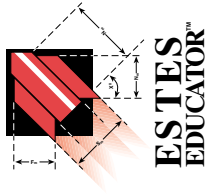

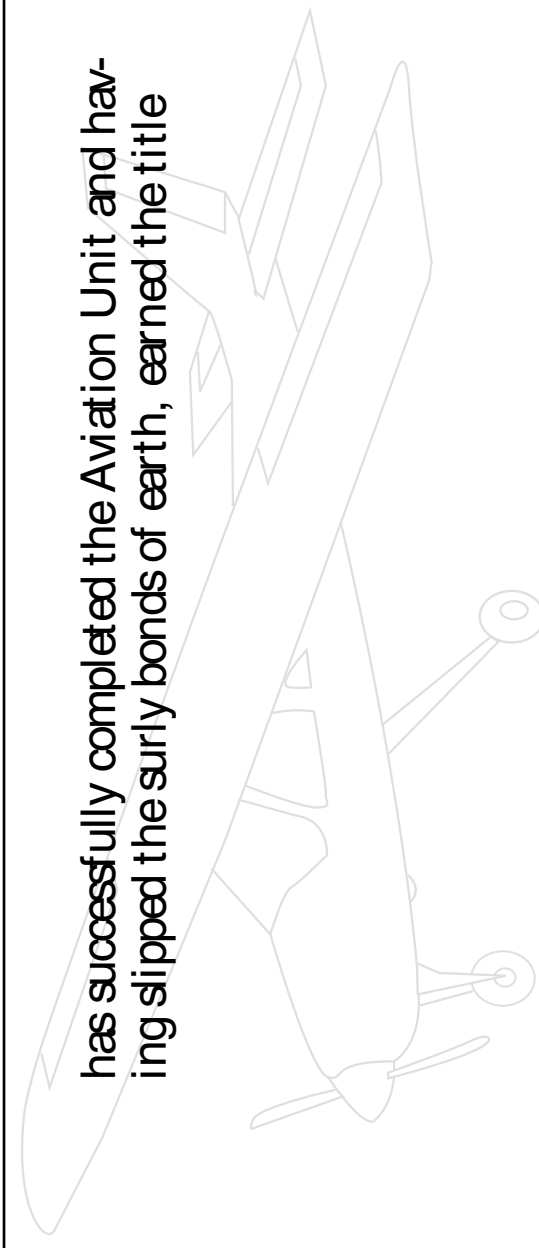

\_\_\_\_\_

has successfully completed the Aviation Unit and having slipped the surly bonds of earth, earned the title



# MASTER AVIATOR

\_\_\_\_\_

Date

# ALTITUDE AWARD

A V I A T I O N C E R T I F I C A T E

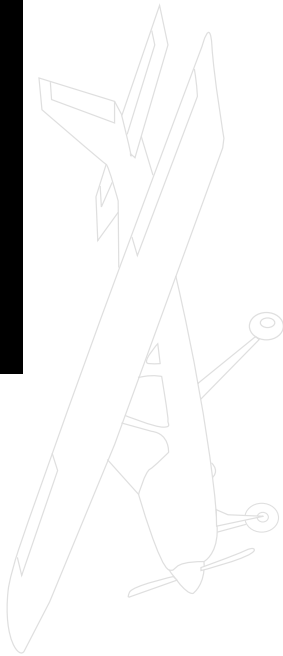

Presented to:

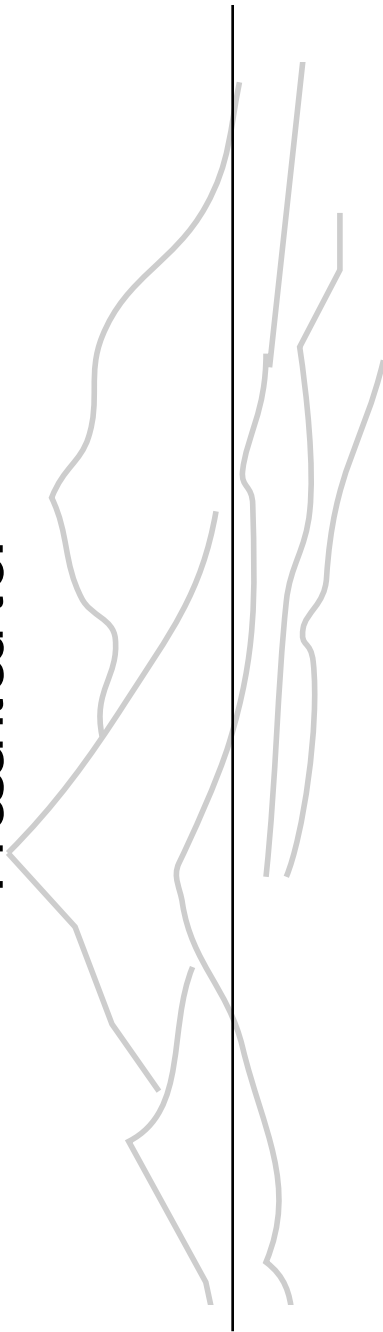

Date

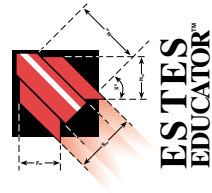

# CIRCLING AWARD

AVIATION CERTIFICATE

Presented to:

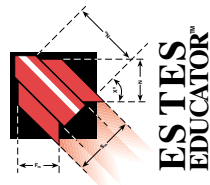

\_\_\_\_\_

\_\_\_\_\_

Date



©Copyright 1995, 1999 Centuri Corporation. All rights reserved.

EST 2851